

CUADRO DE DETALLES GENERALES				
Nº PLANO	Nº PLANCHA	DETALLE	NOMBRE	
A-013	A-502	DET-1	MACHON VENTANA GRANDE	
A-013	A-502	DET-2	MACHON VENTANA PEQUENA	
A-013	A-502	DET-3	PELDAÑOS ESCALERA	
A-013	A-502	DET-4	ALFAJA Y FLANJE METALICO	
A-013	A-502	DET-5	FLANJE METALICO	
A-013	A-502	DET-6	GUARDAESCOBAS	
A-013	A-502	DET-7	ESPEJOS BAÑOS	
A-013	A-502	DET-8	MUROS DIVISORIOS BAÑOS	
A-013	A-502	DET-9	DESPIECE ENCHAPES BAÑOS Y/O COCINAS	
A-013	A-502	DET-10	PASAMANOS ESCALERA	
A-014	A-503	DET-11	MESON LABORATORIO Y BAÑOS	
A-014	A-503	DET-12	PISO POCETA	
A-014	A-503	DET-13	BARRANDA DE RAMPA	
A-014	A-503	DET-14	RAMPA CONTRAPISO	
A-014	A-503	DET-15	VIGA CANAL	
A-014	A-503	CS1	DETALLE ESQUEMATICO CORTASOL	

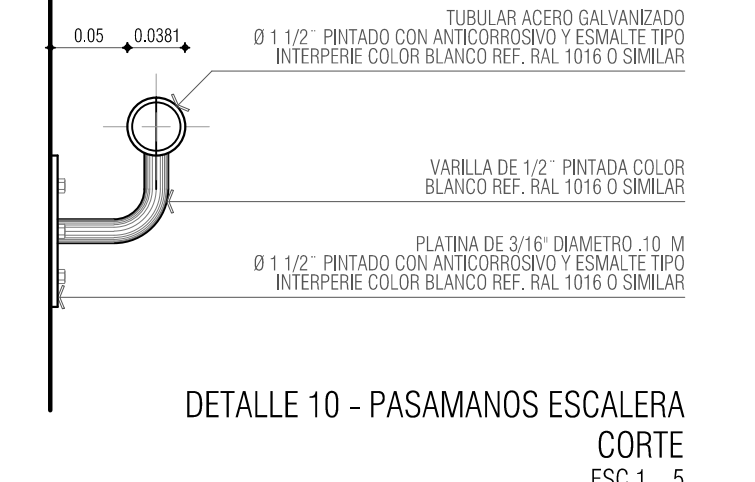
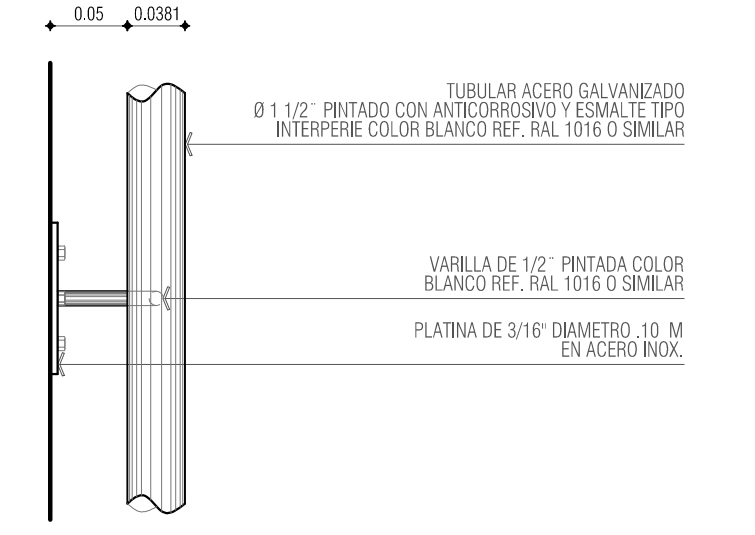
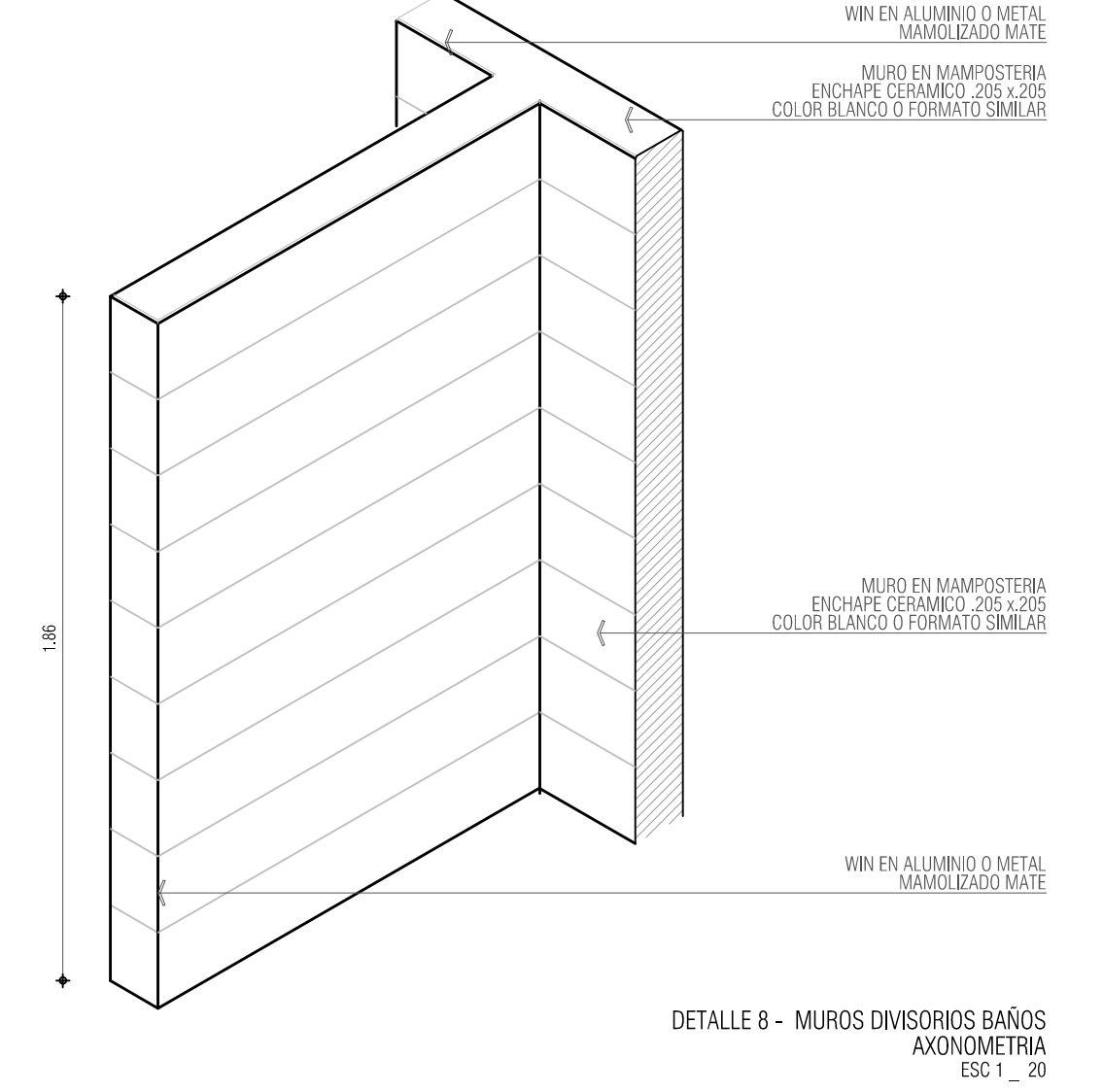
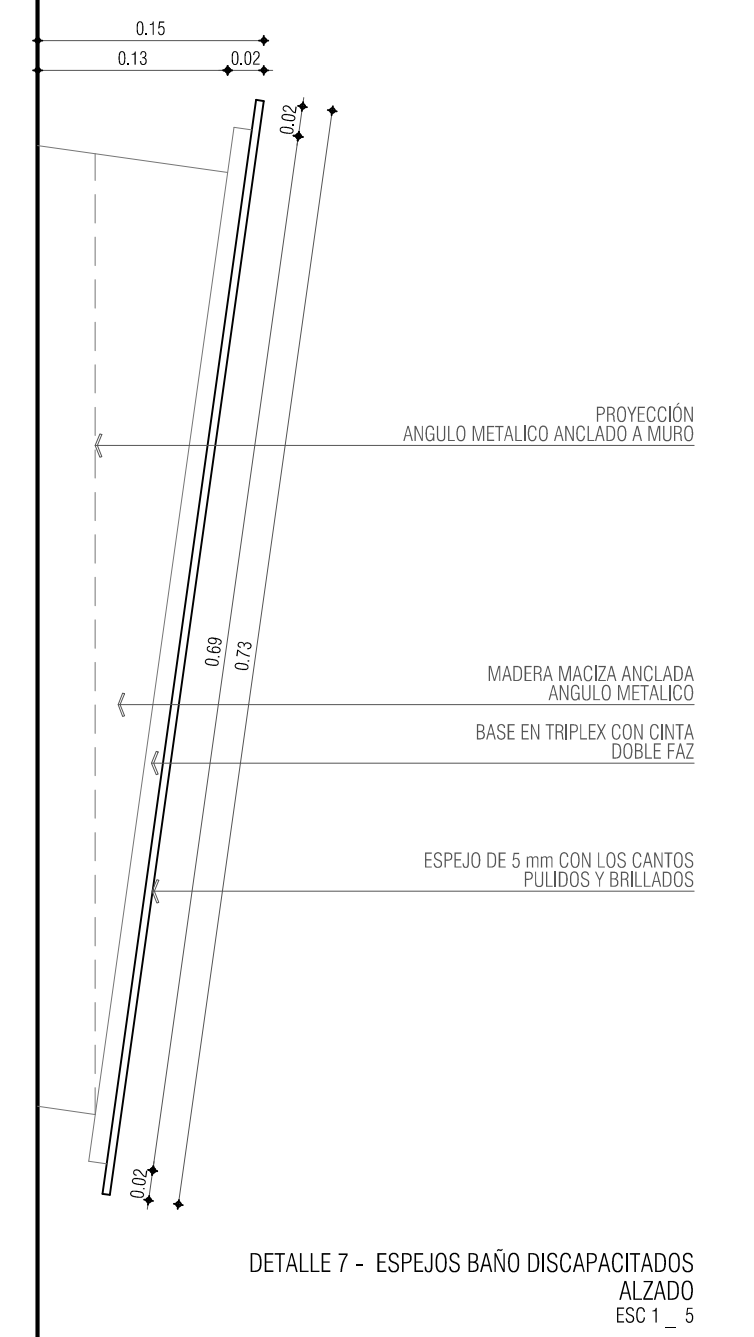
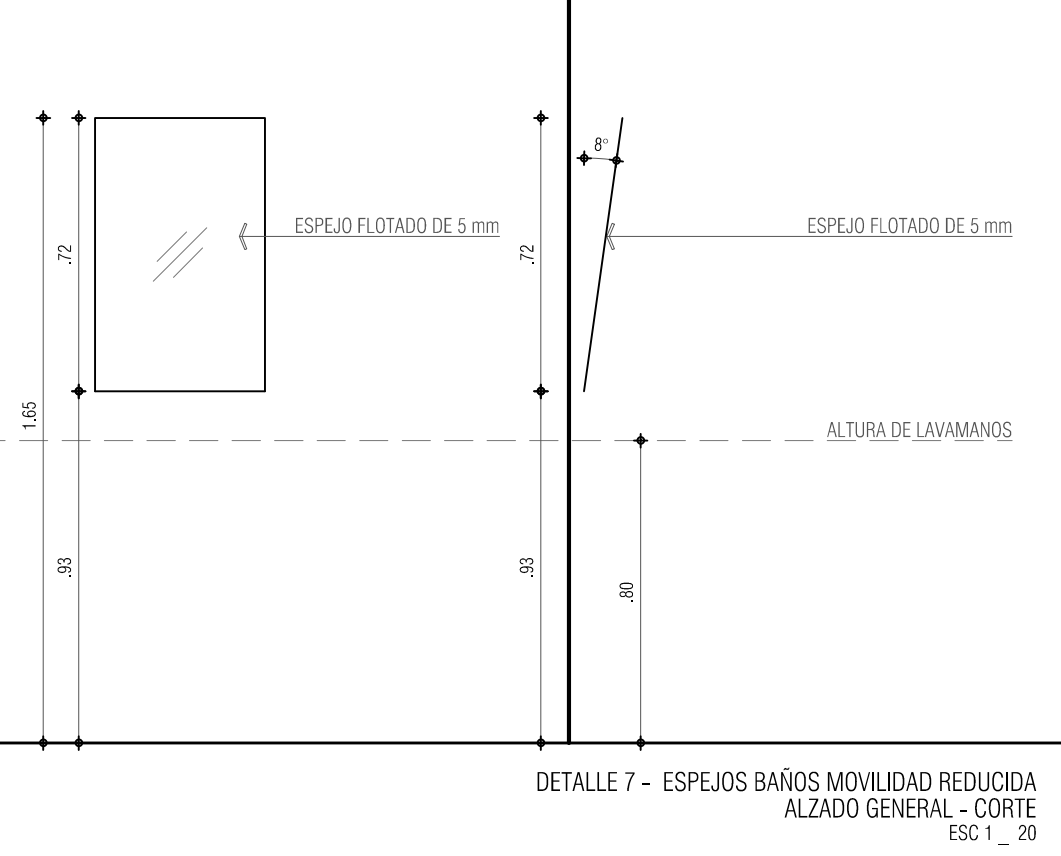
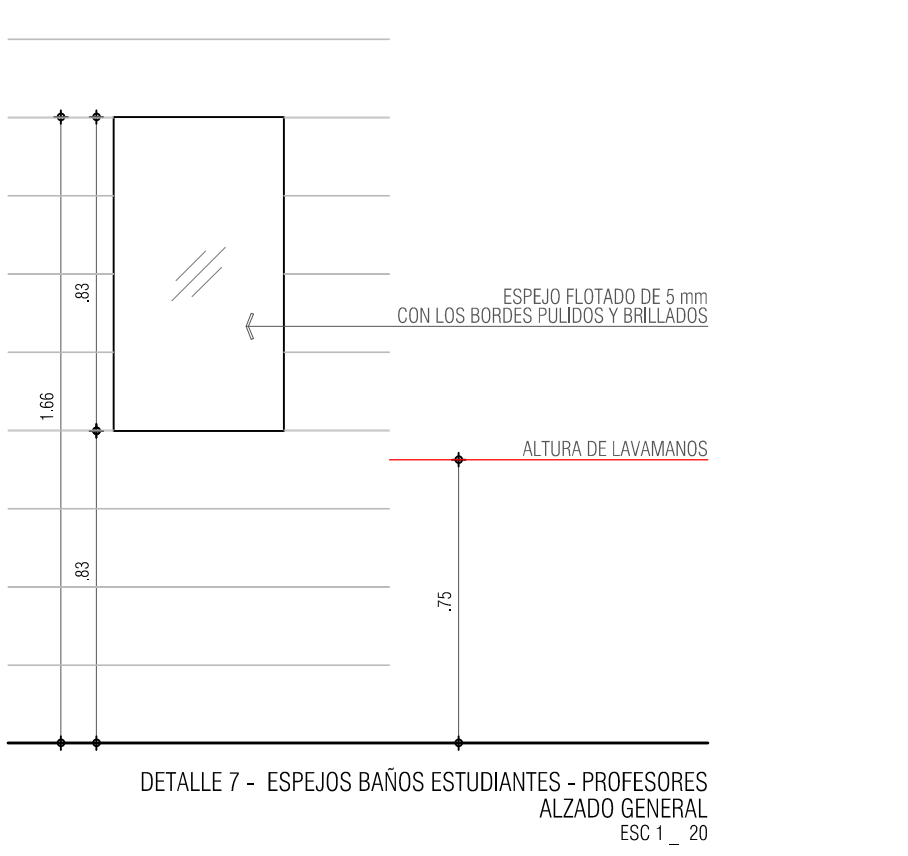
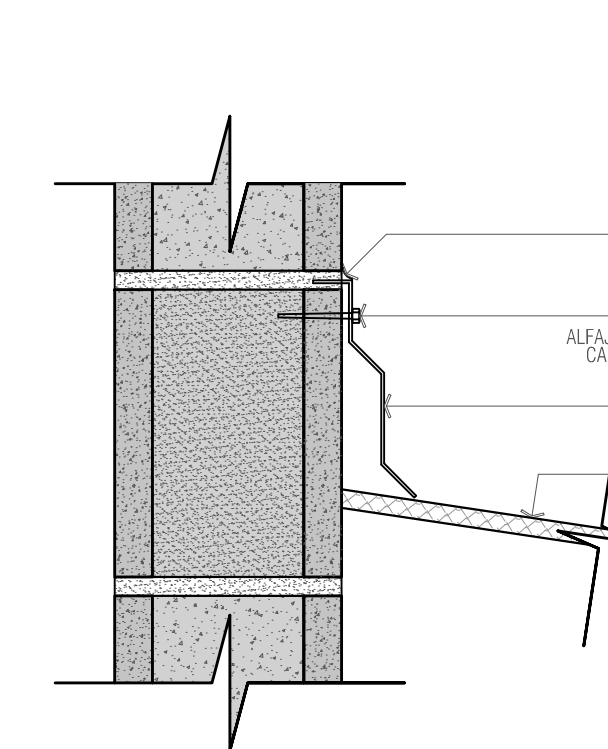
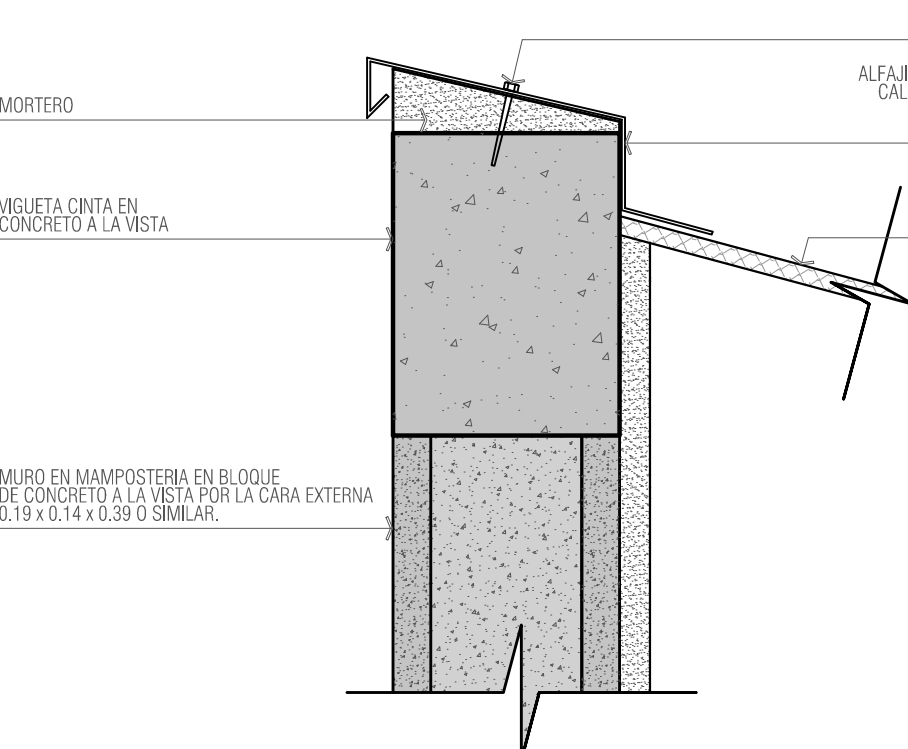
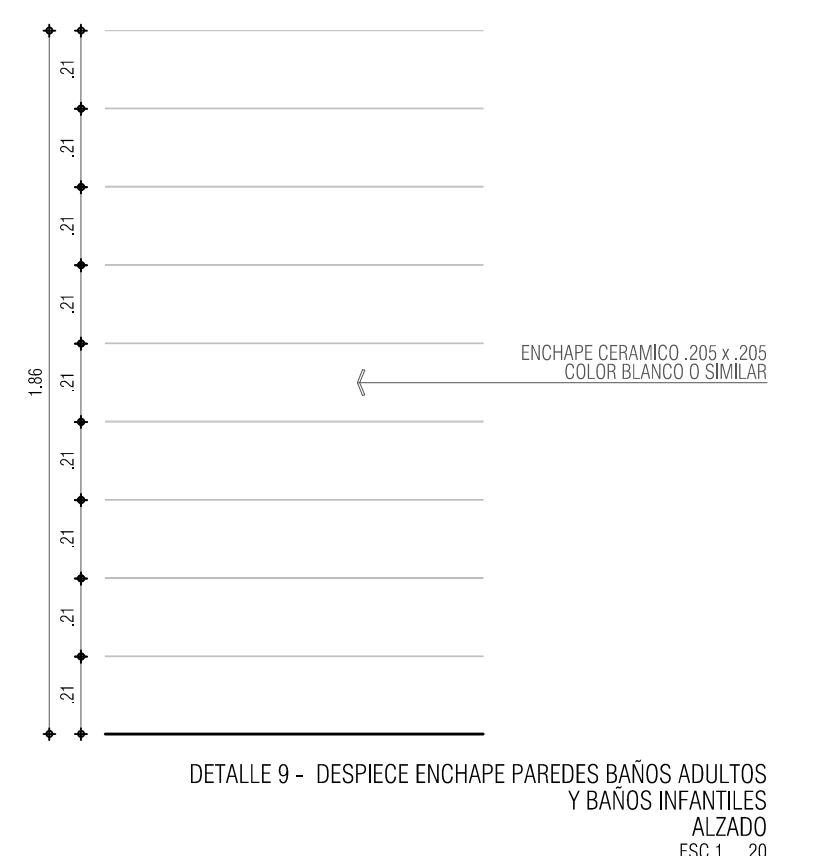
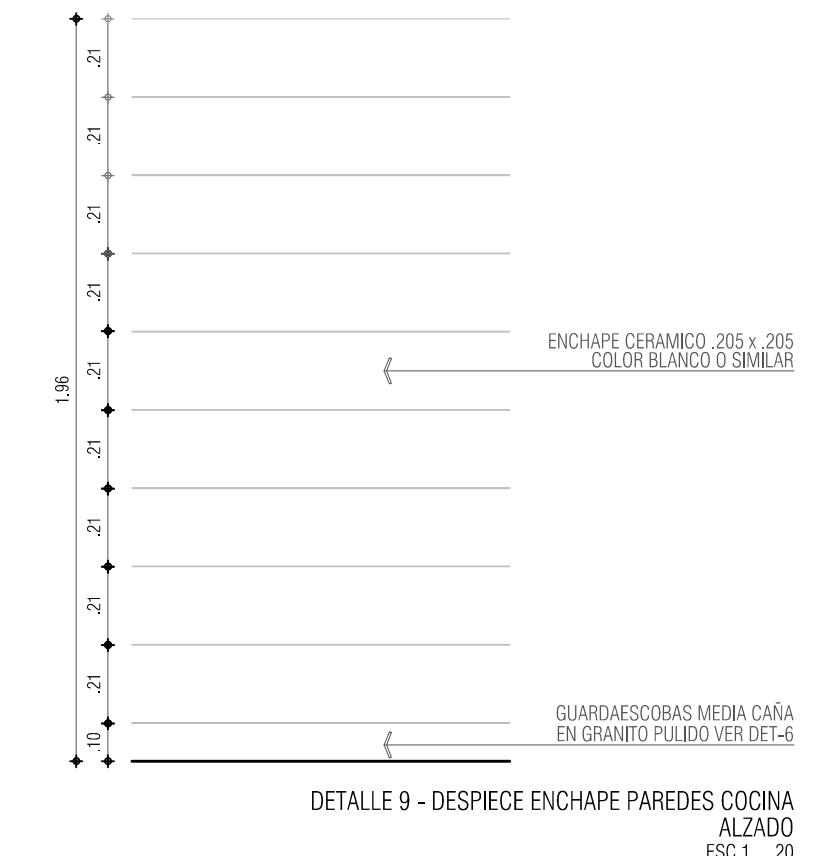
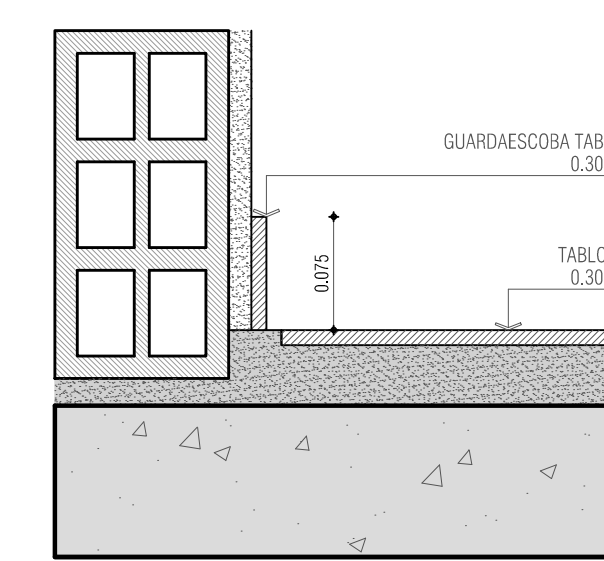
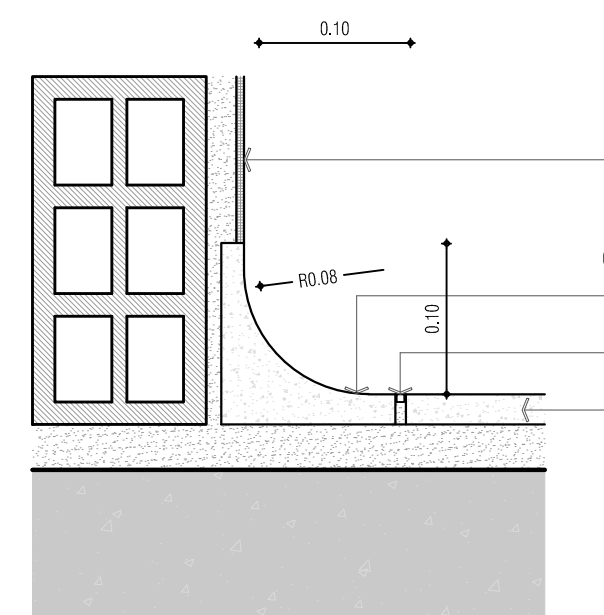
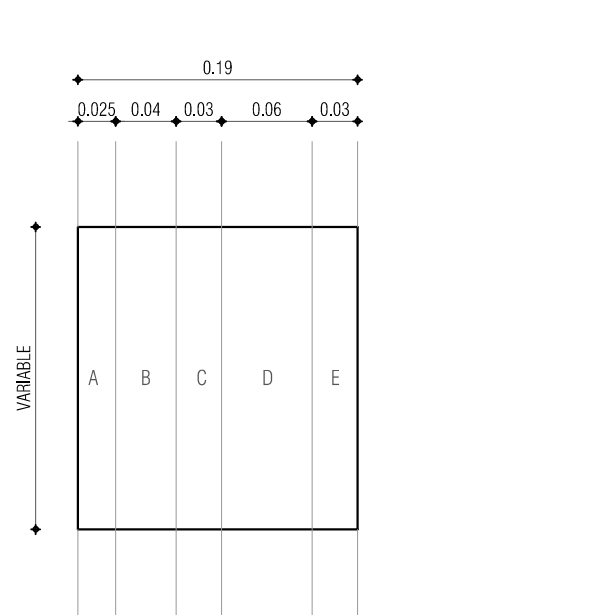
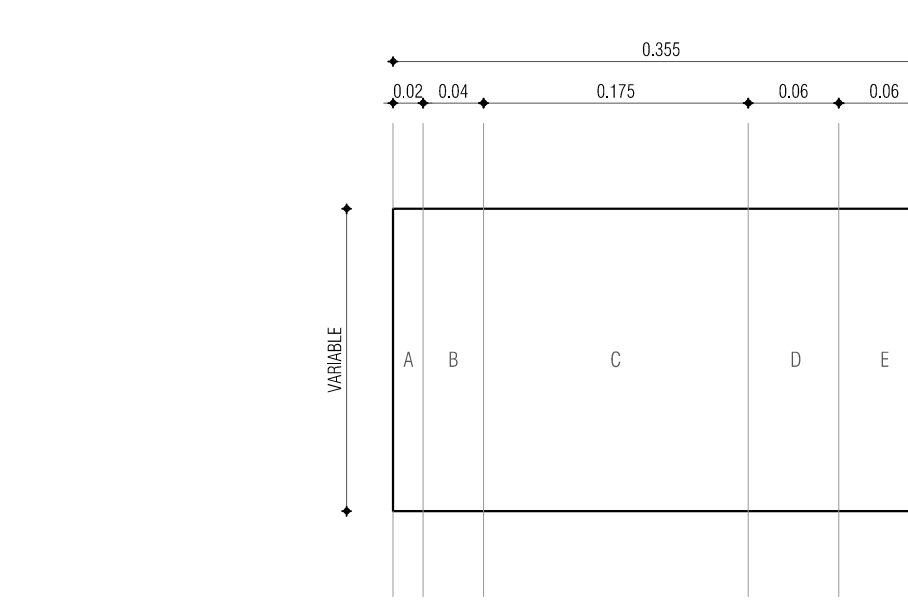

NOTA: CUANDO LOS ESPEJOS TENGAN UN LARGO MAYOR DE 1.40 mt. DEBERAN ESTAR DOTADOS DE 1 cm. DE ALTURA DEL BORDO Y DEL ESPEJO DEPENDERA DEL FORMATO UTILIZADO EN LA CONSTRUCCION PROYECTADA PARA PUNTA A N TIPO DE ACUBI EN EL EMPLEO.

NOTA: EL ESPEJO EN EL BAÑO DE DISCAPACITADOS DEBERA TENER UNA INCLINACION DE 10 GRADOS HACIA EL USUARIO.

VERSIONES	
FECHA:	OBSERVACIONES
10-02-2017	VERSION 1

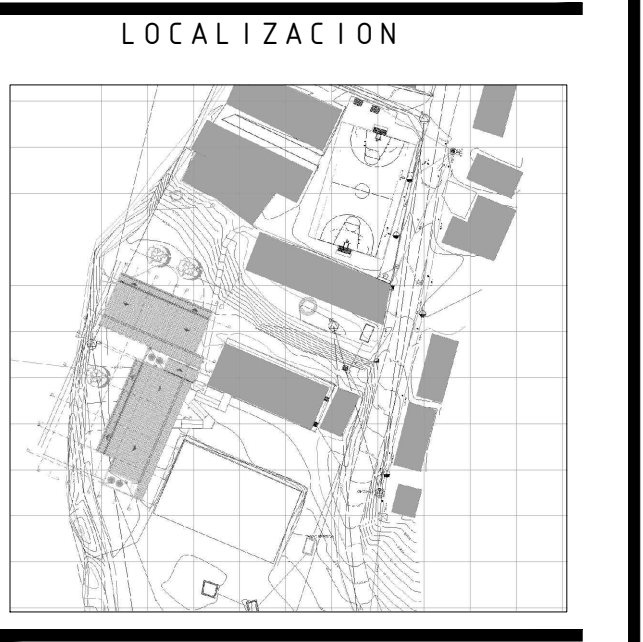

PROYECTO JORNADA ÚNICA

Jornada Única

MINEDUCACIÓN TODOS POR UN NUEVO PAÍS

Ministerio de Educación

Bogotá, Colombia



No. CONTRATO:

PAF-JU09-G09DC-2015



INTERVENTORIA

CONSORCIO

JORNADA UNICA BCG

ARQ. EDUARDO RUGELES

MATRICULA PROF: 68700-49940STD

ARQUITECTO DISEÑADOR:

ARQ. ADRIANA YOLIMA PARRA

M.P. A25302004-52869259

DIRECTOR DE CONSULTORIA:

ARQ. NHOIRA RAQUEL PONGUITA

MAT. N° 2570052129 CND

EQUIPO DE DISEÑO

ARQUITECTONICO

JGS2 ATELIER SAS

ARQUITECTO ENCARGADO:

ARQ. MANUEL ANTONIO ENCISO SANCHEZ

MAT. N° 25700 0172 CND

ARQ. DIANA MILENA AVENDAÑO BRUALDO

MAT. N° A25042004-46681798

LOCALIZACION:

MUNICIPIO DE PASTO

DEPARTAMENTO DE NARIÑO

PROYECTO:

C.E.M. LA VICTORIA

GRUPO 9

CONTIENE:

CUADRO DE DETALLES

DETALLES GENERALES

ESCALA:

FECHA:

INDICADAS FEBRERO 2017

PLANO No. DE 13

P-70-E / A-502 14