

NOTA: El acotado varia de acuerdo a la referencia del aparato

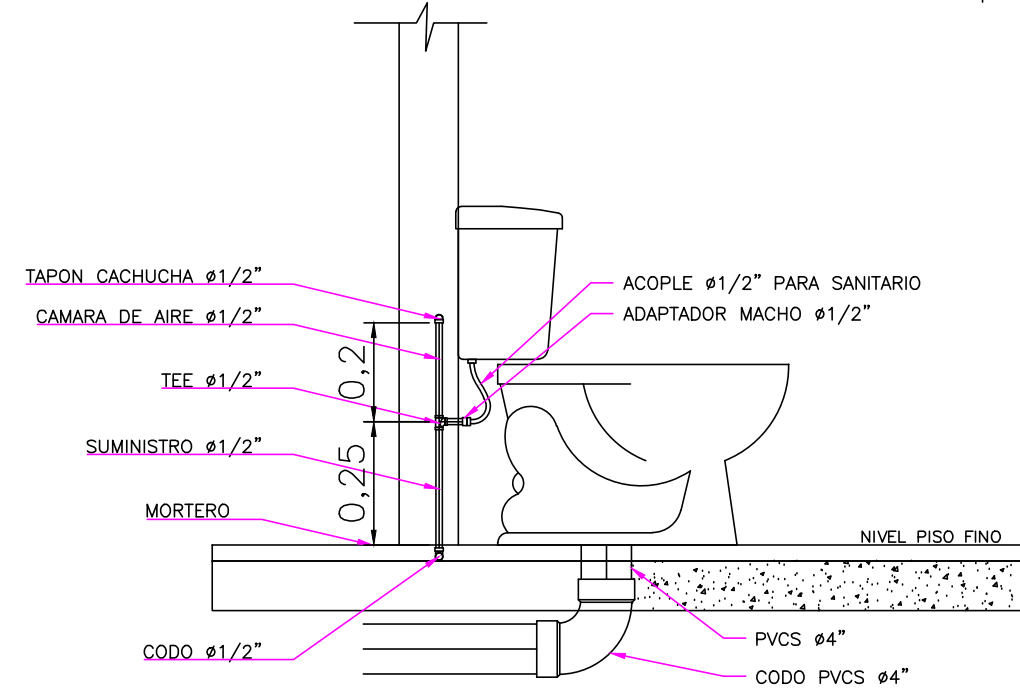

DETALLE MONTAJE INODORO Sin Escala

NOTA: El acotado varia de acuerdo a la referencia del aparato

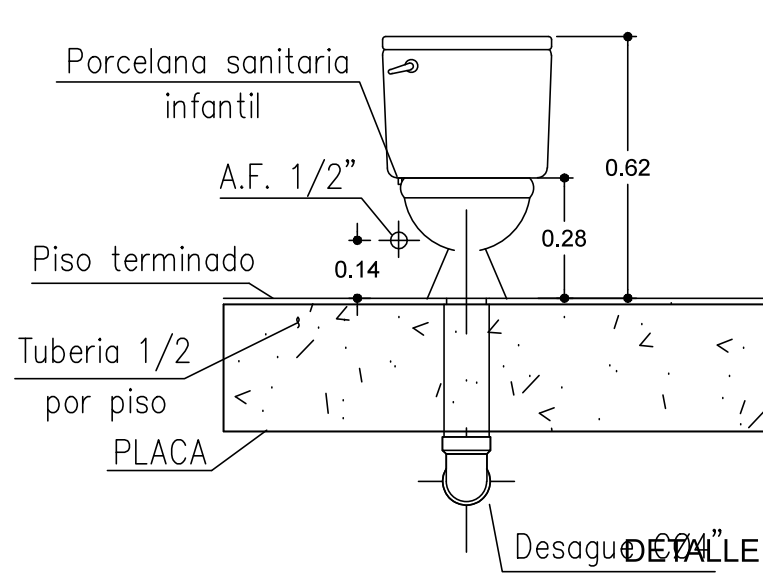

DETALLE MONTAJE INODORO INFANTIL Sin Escala

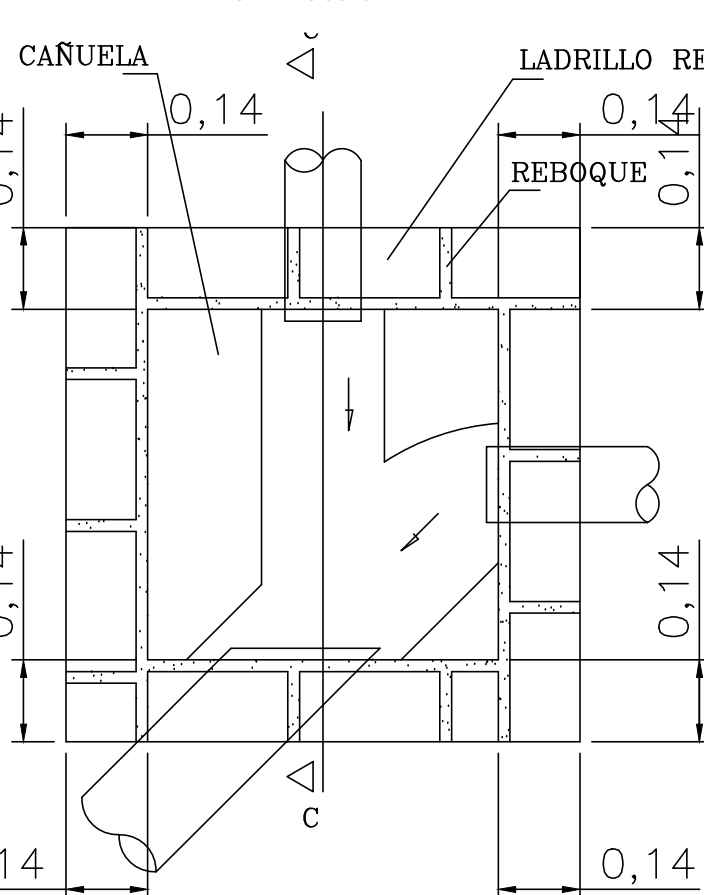

TAPA CAJA DE INSPECCION

PLANTA CAJA DE INSPECCION

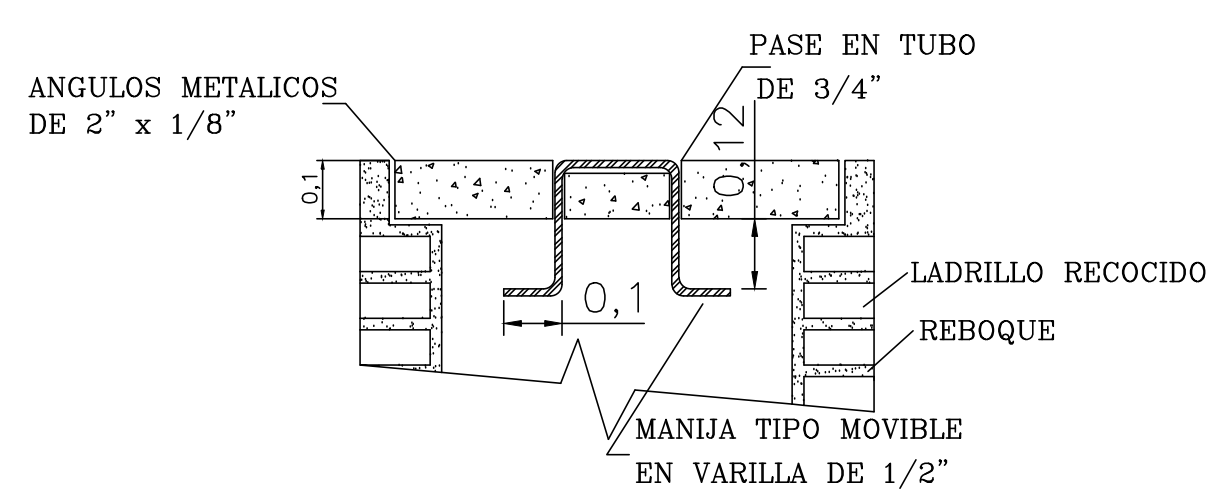

CONCRETO PLACA DE CONCRETO REFORZADO CON HIERRO DE 3/8 RECEO COMPACTADO

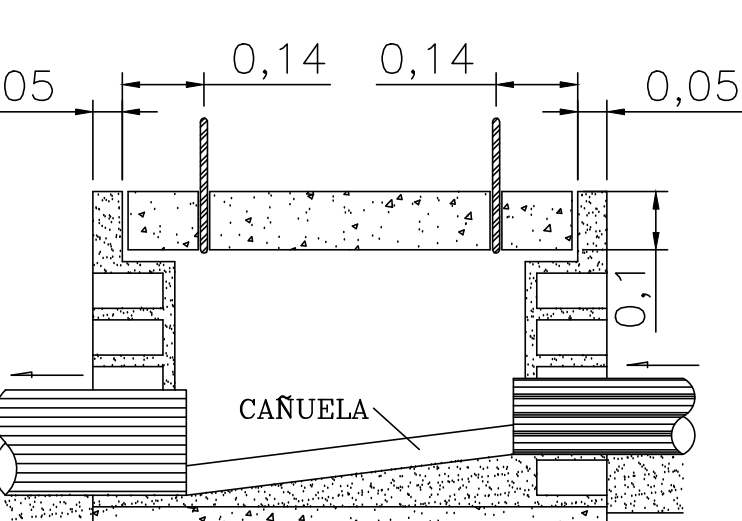

CONCRETO PLACA DE CONCRETO REFORZADO CON HIERRO DE 3/8 RECEO COMPACTADO

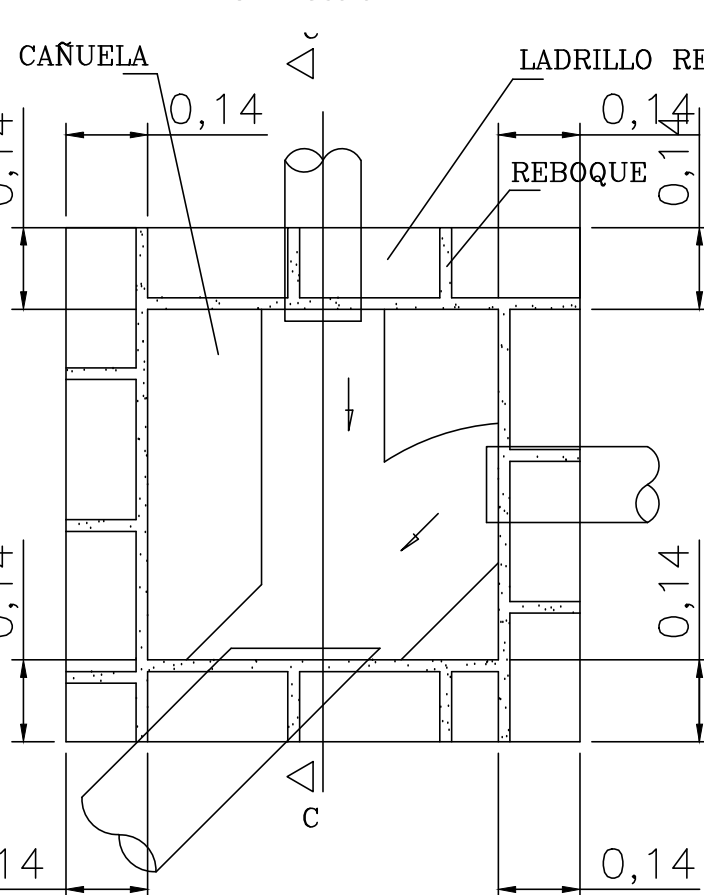

PLANTA CAJA DE INSPECCION

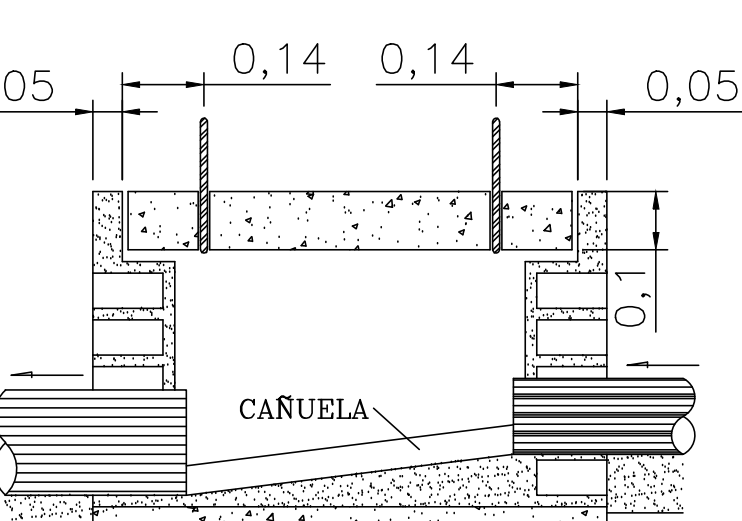

CONCRETO PLACA DE CONCRETO REFORZADO CON HIERRO DE 3/8 RECEO COMPACTADO

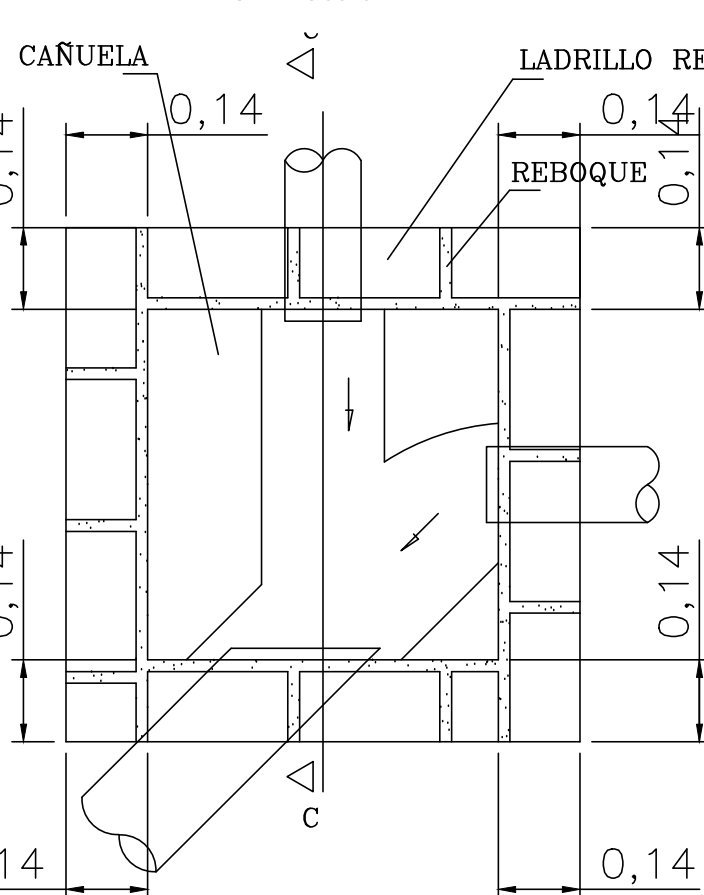

PLANTA CAJA DE INSPECCION

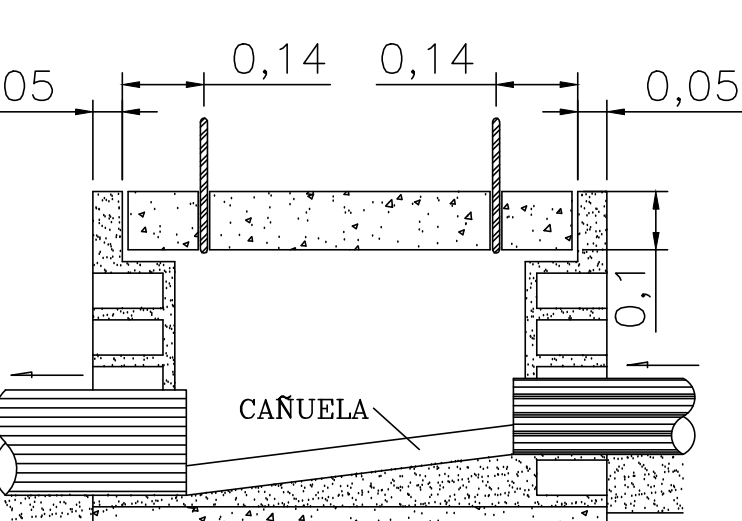

CONCRETO PLACA DE CONCRETO REFORZADO CON HIERRO DE 3/8 RECEO COMPACTADO

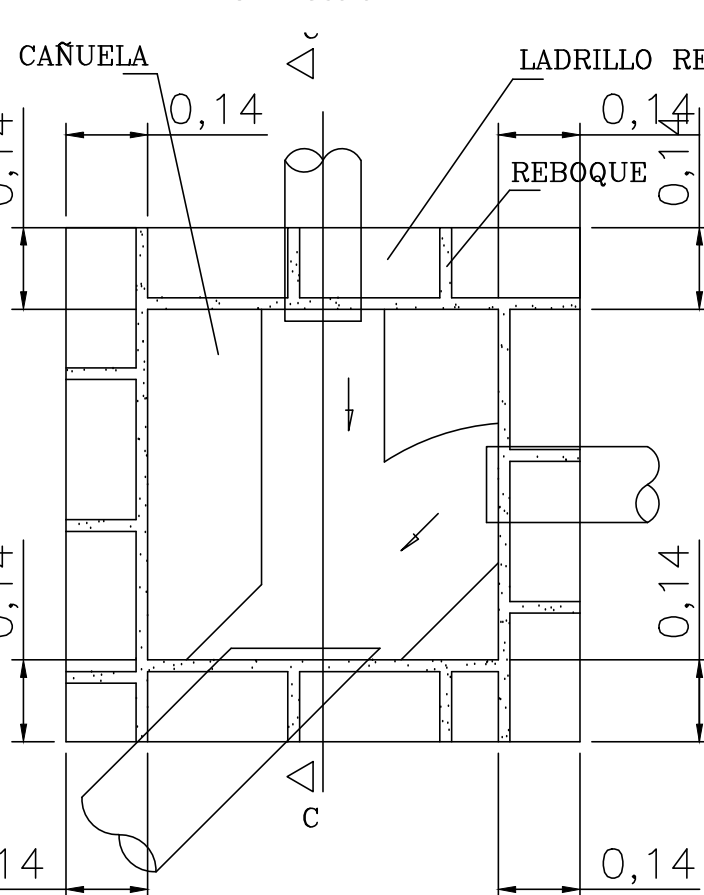

PLANTA CAJA DE INSPECCION

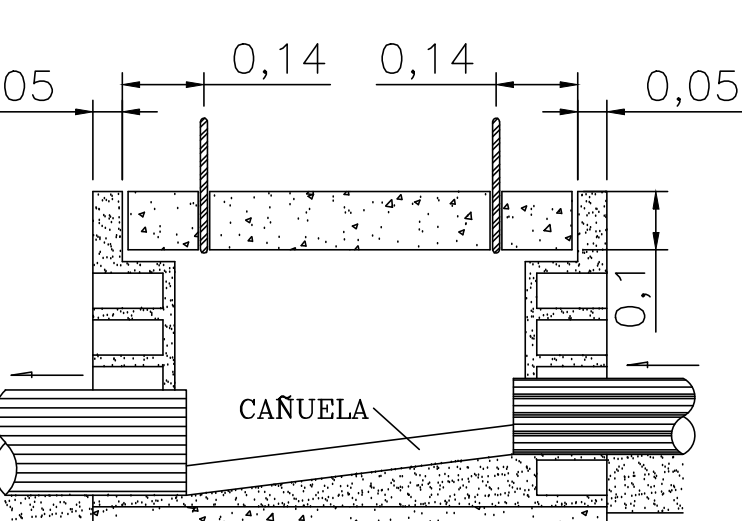

CONCRETO PLACA DE CONCRETO REFORZADO CON HIERRO DE 3/8 RECEO COMPACTADO

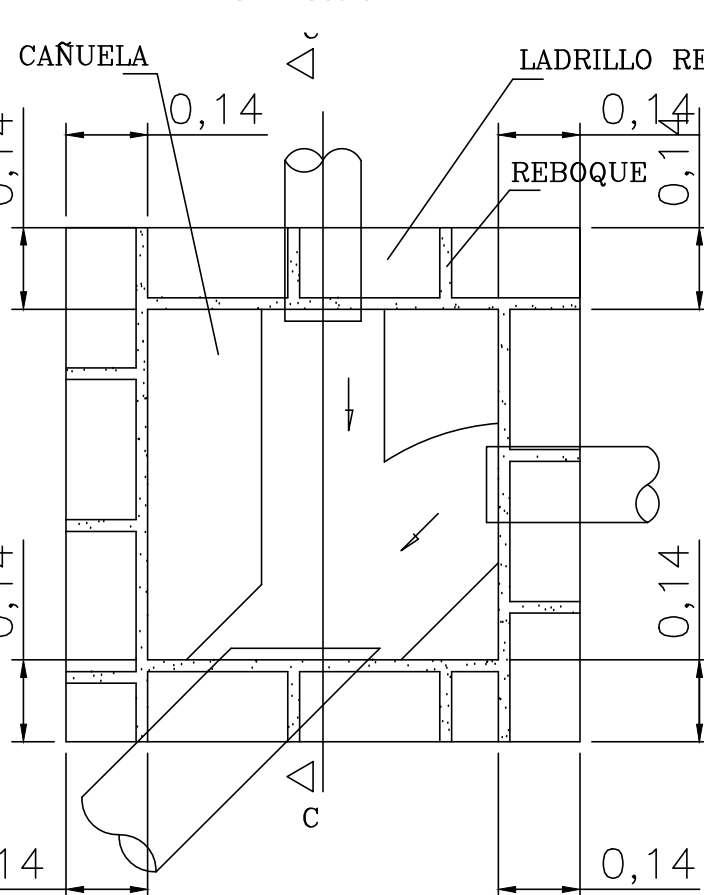

PLANTA CAJA DE INSPECCION

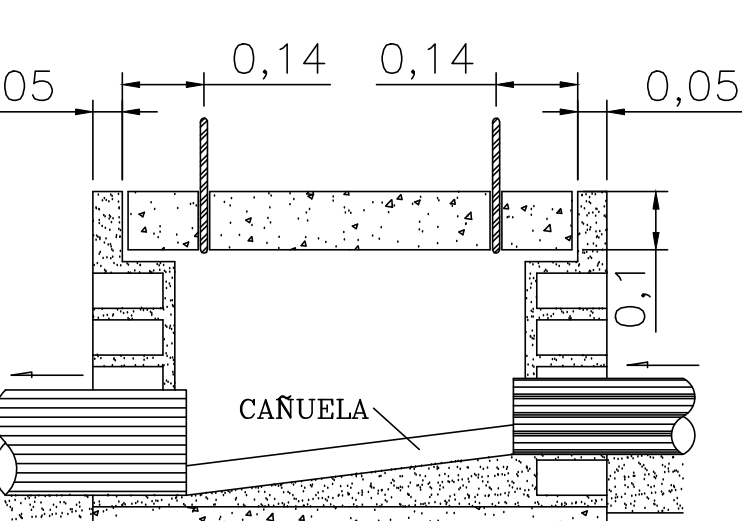

CONCRETO PLACA DE CONCRETO REFORZADO CON HIERRO DE 3/8 RECEO COMPACTADO

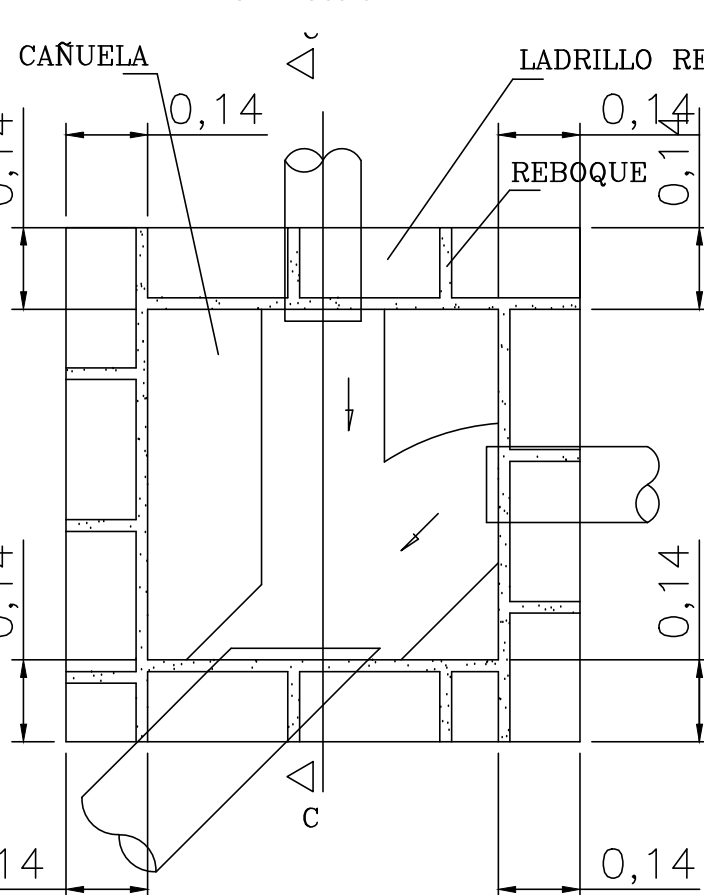

PLANTA CAJA DE INSPECCION

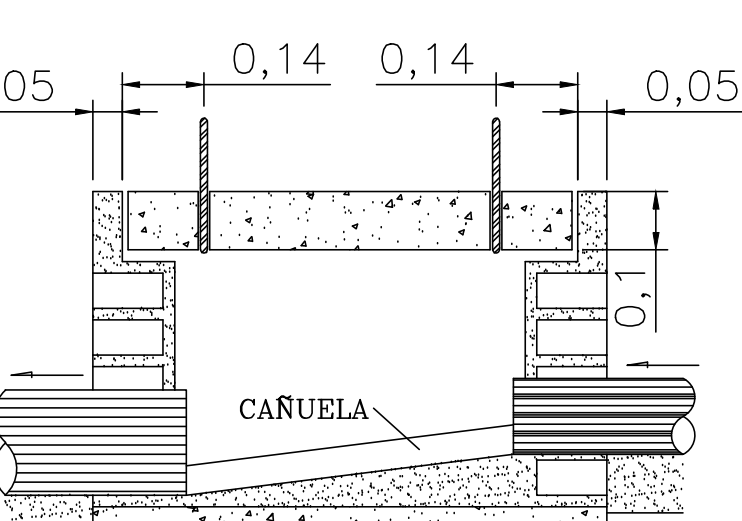

CONCRETO PLACA DE CONCRETO REFORZADO CON HIERRO DE 3/8 RECEO COMPACTADO

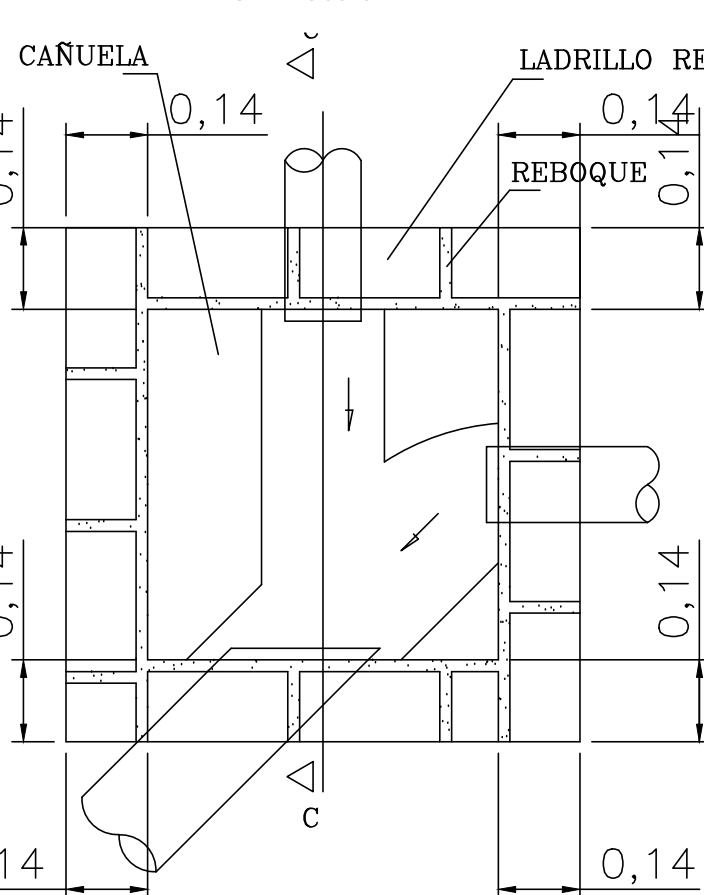

PLANTA CAJA DE INSPECCION

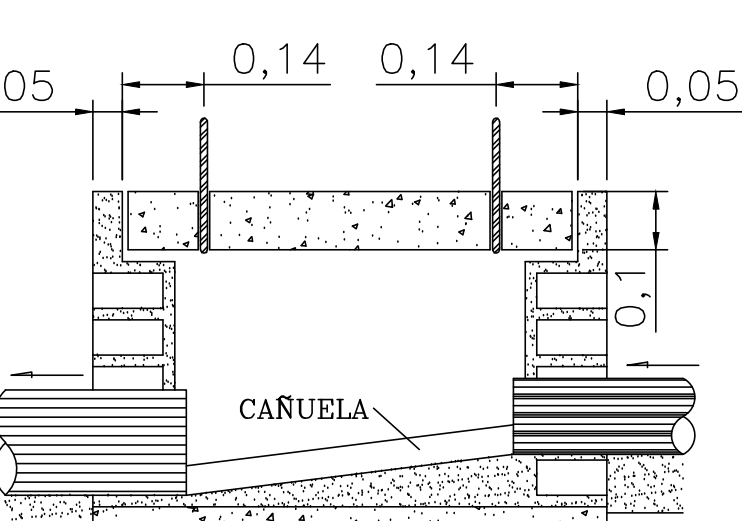

CONCRETO PLACA DE CONCRETO REFORZADO CON HIERRO DE 3/8 RECEO COMPACTADO

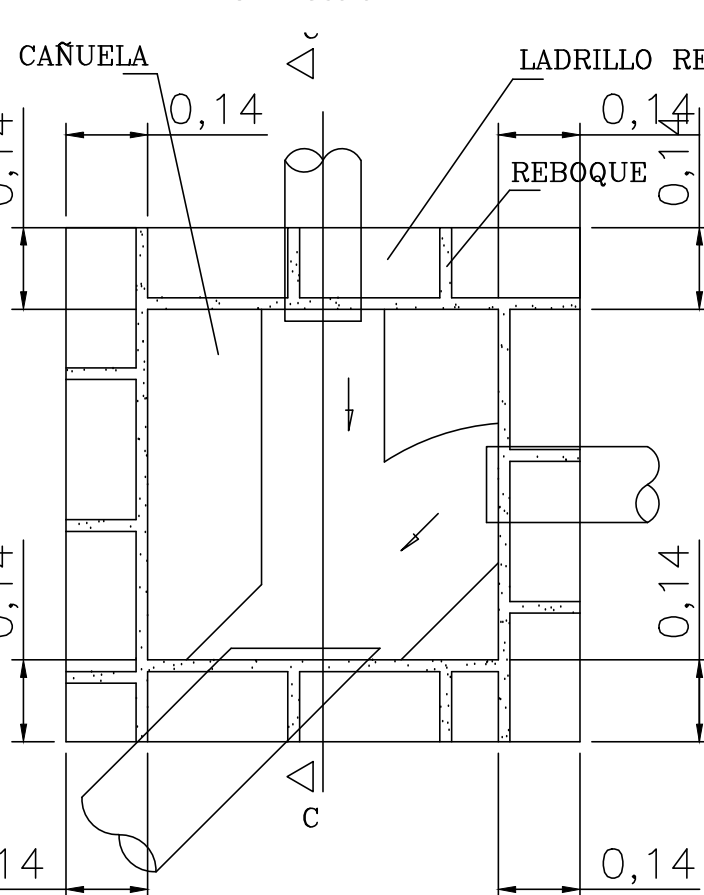

PLANTA CAJA DE INSPECCION

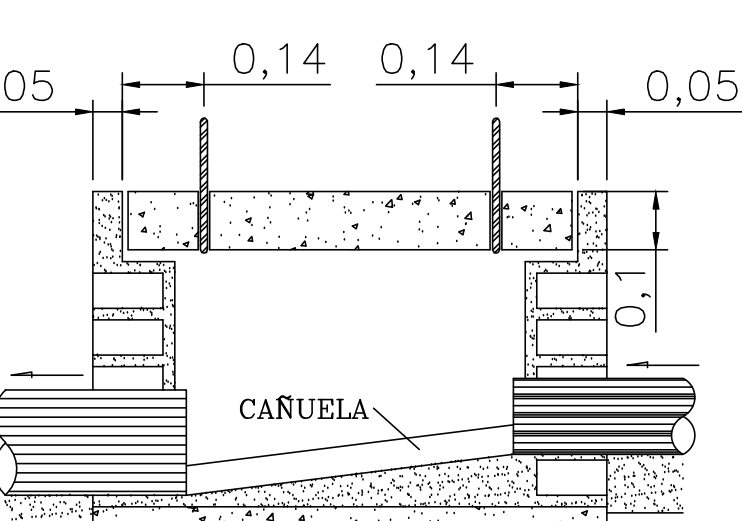

CONCRETO PLACA DE CONCRETO REFORZADO CON HIERRO DE 3/8 RECEO COMPACTADO

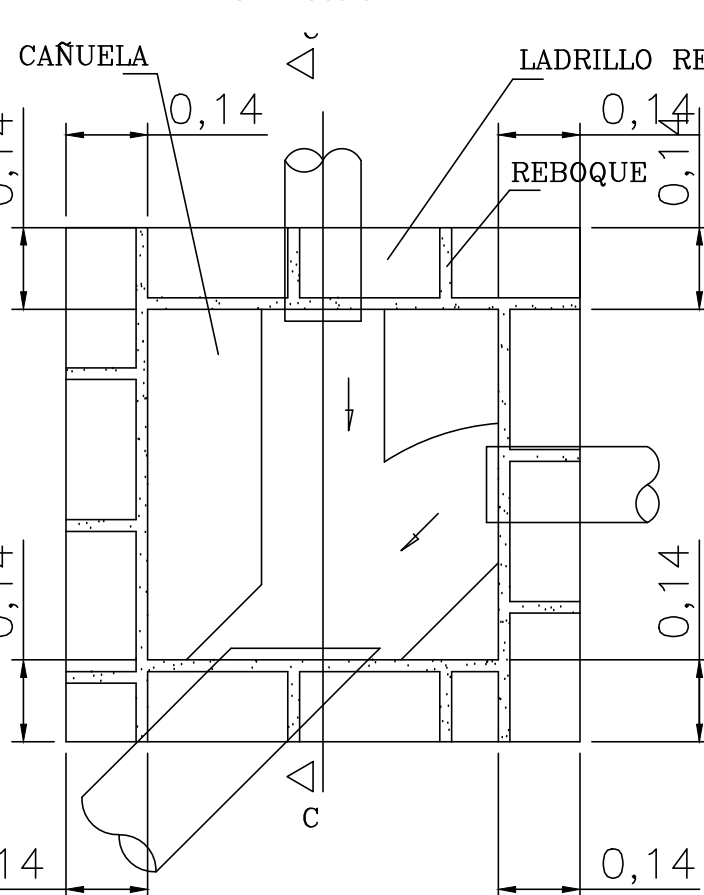

PLANTA CAJA DE INSPECCION

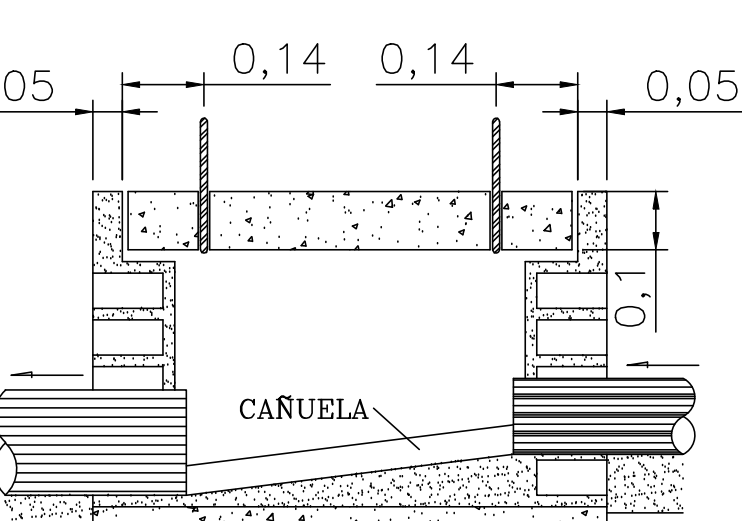

CONCRETO PLACA DE CONCRETO REFORZADO CON HIERRO DE 3/8 RECEO COMPACTADO

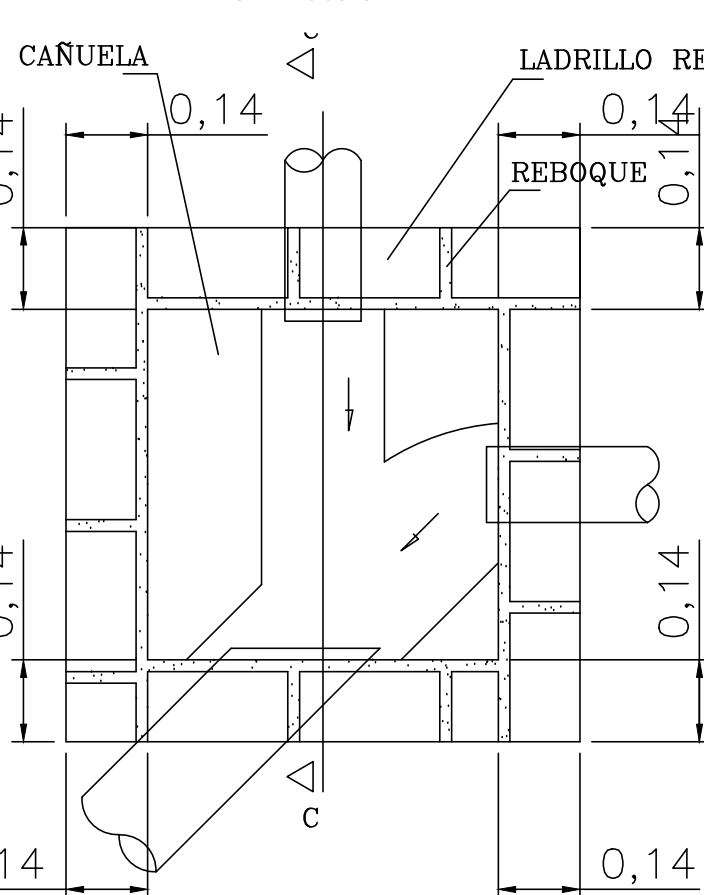

PLANTA CAJA DE INSPECCION

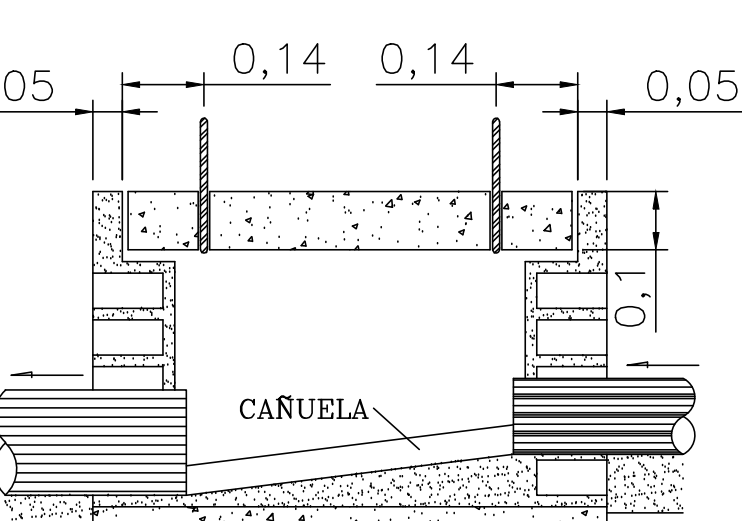

CONCRETO PLACA DE CONCRETO REFORZADO CON HIERRO DE 3/8 RECEO COMPACTADO

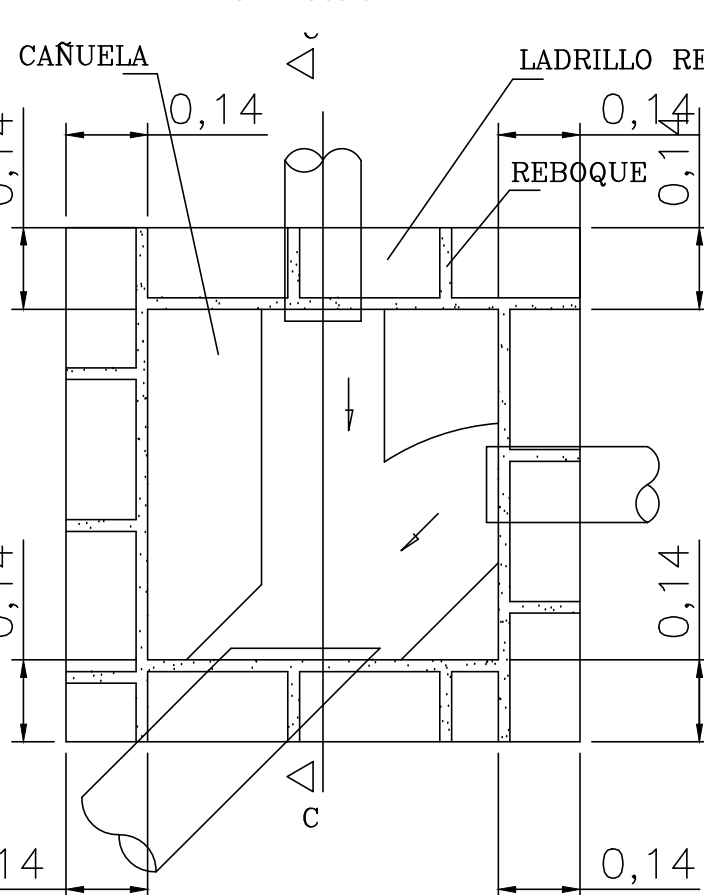

PLANTA CAJA DE INSPECCION

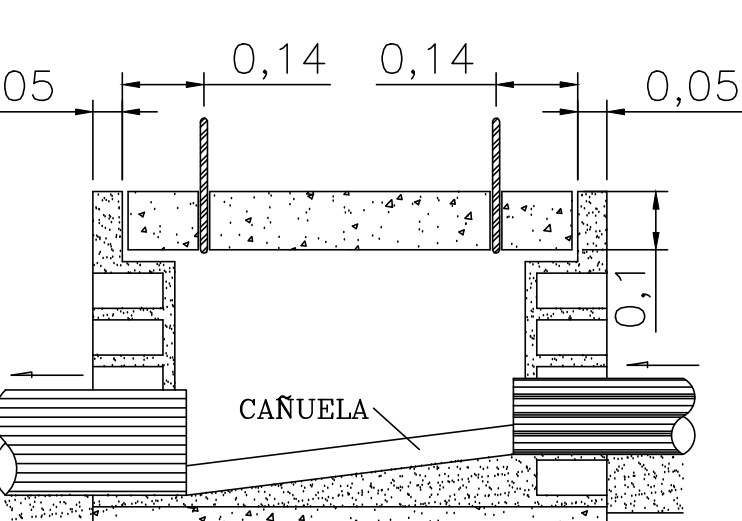

CONCRETO PLACA DE CONCRETO REFORZADO CON HIERRO DE 3/8 RECEO COMPACTADO

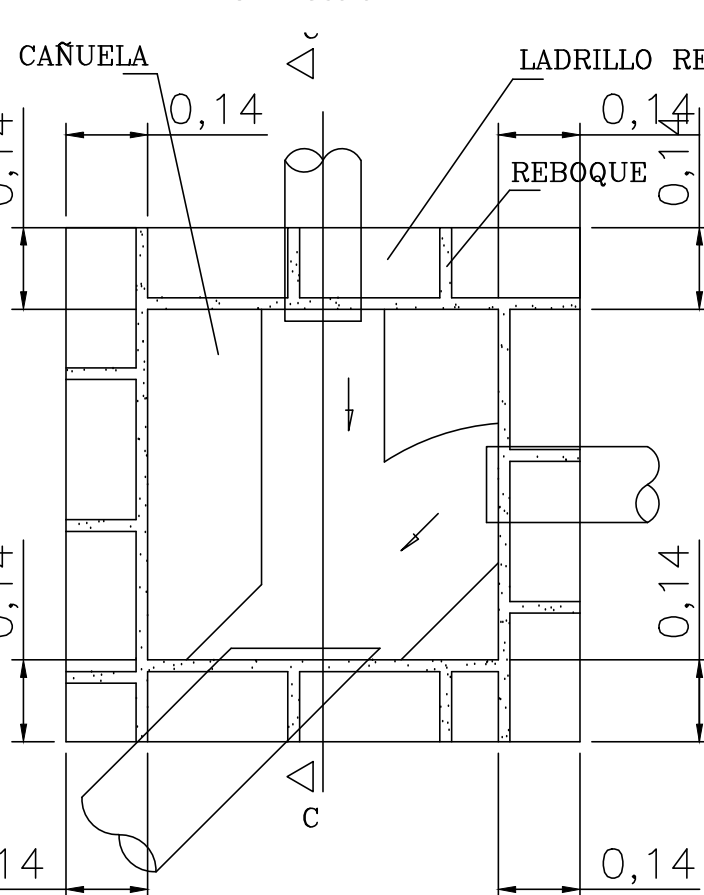

PLANTA CAJA DE INSPECCION

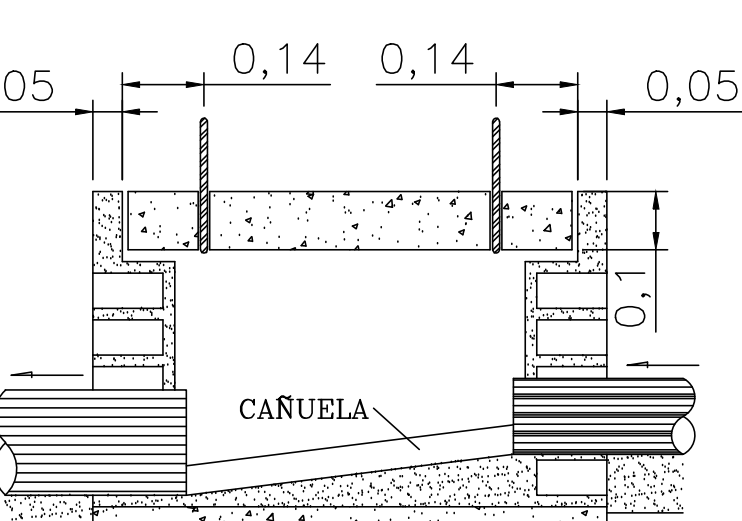

CONCRETO PLACA DE CONCRETO REFORZADO CON HIERRO DE 3/8 RECEO COMPACTADO

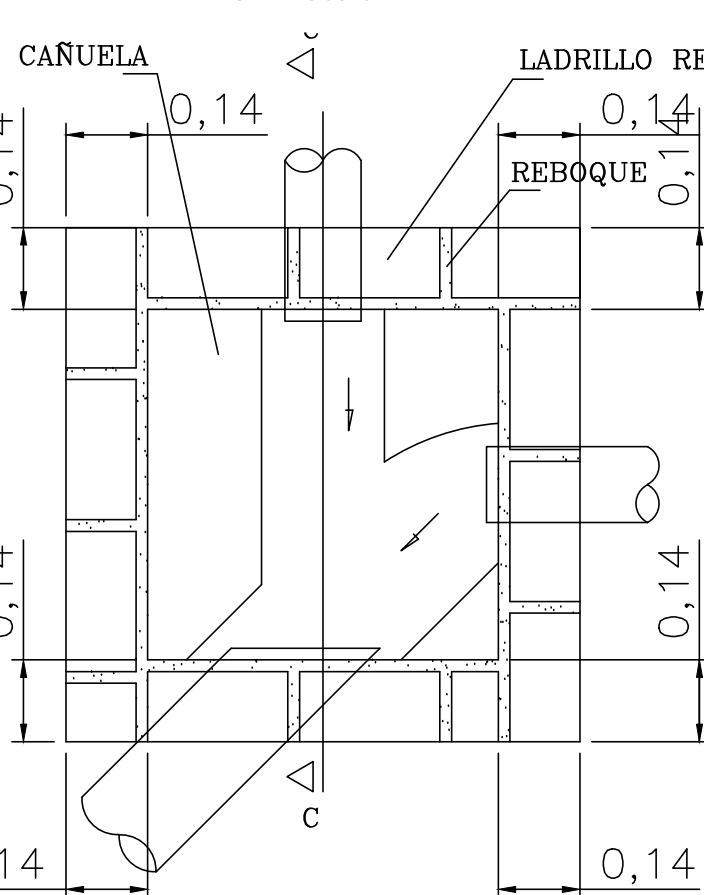

PLANTA CAJA DE INSPECCION

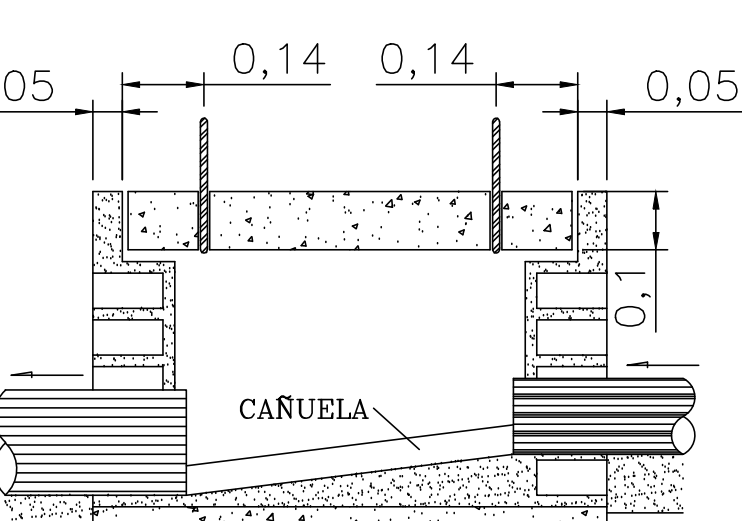

CONCRETO PLACA DE CONCRETO REFORZADO CON HIERRO DE 3/8 RECEO COMPACTADO

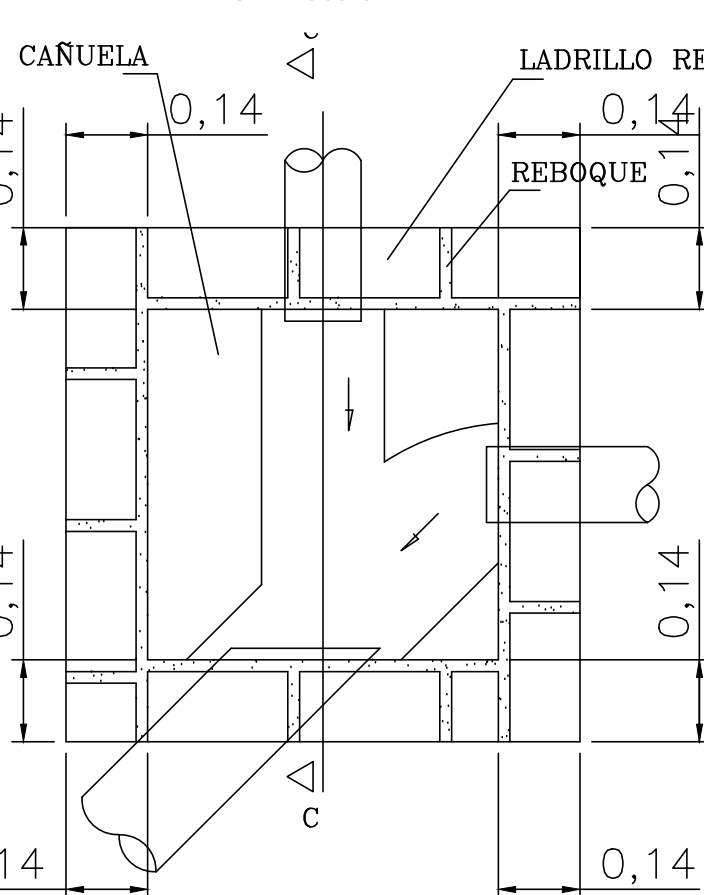

PLANTA CAJA DE INSPECCION

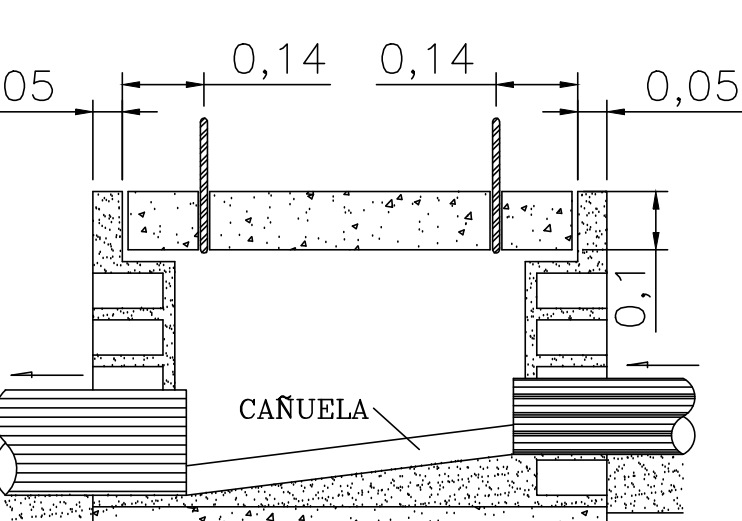

CONCRETO PLACA DE CONCRETO REFORZADO CON HIERRO DE 3/8 RECEO COMPACTADO

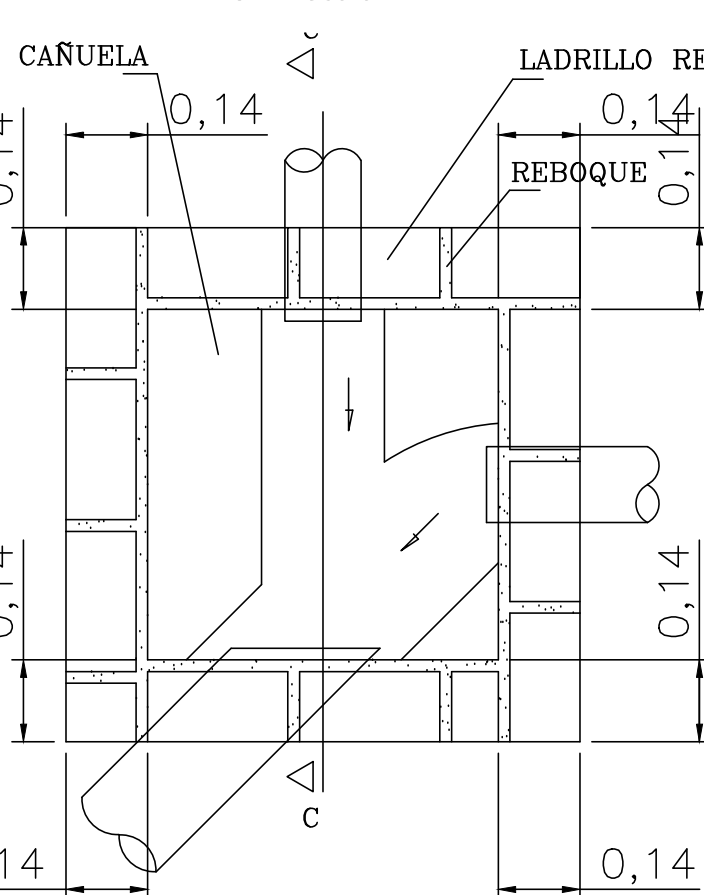

PLANTA CAJA DE INSPECCION

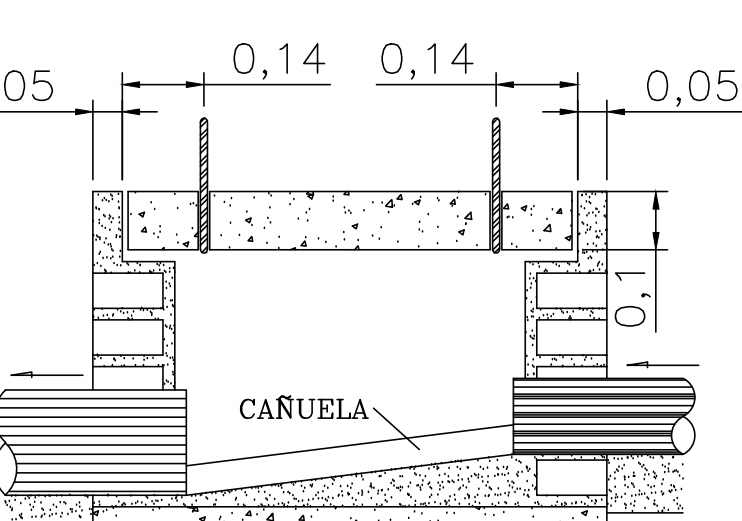

CONCRETO PLACA DE CONCRETO REFORZADO CON HIERRO DE 3/8 RECEO COMPACTADO

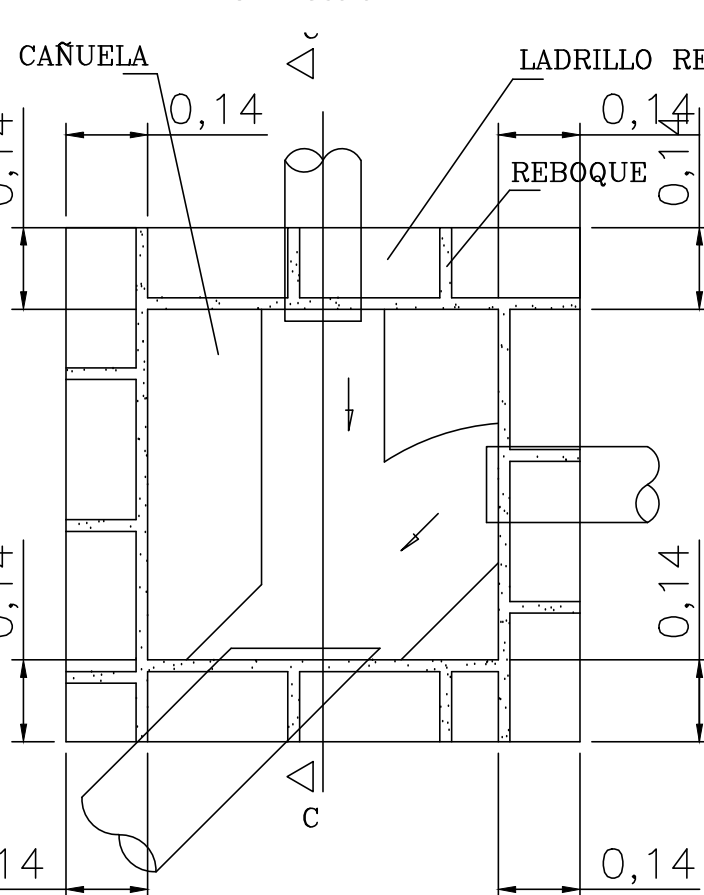

PLANTA CAJA DE INSPECCION

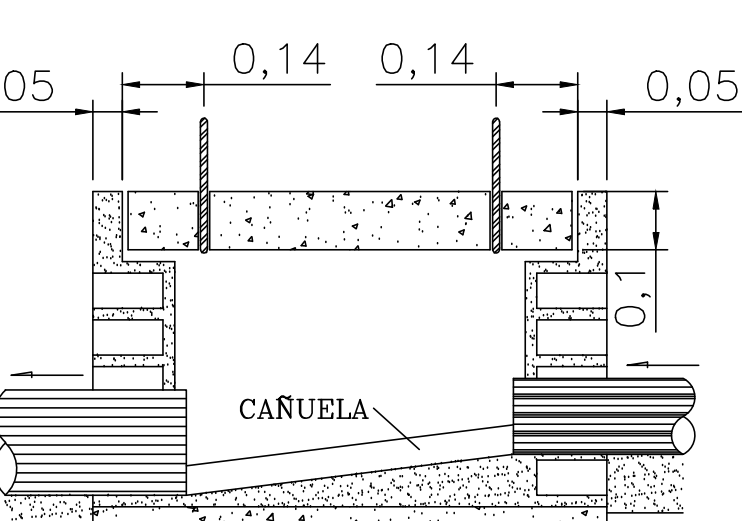

CONCRETO PLACA DE CONCRETO REFORZADO CON HIERRO DE 3/8 RECEO COMPACTADO

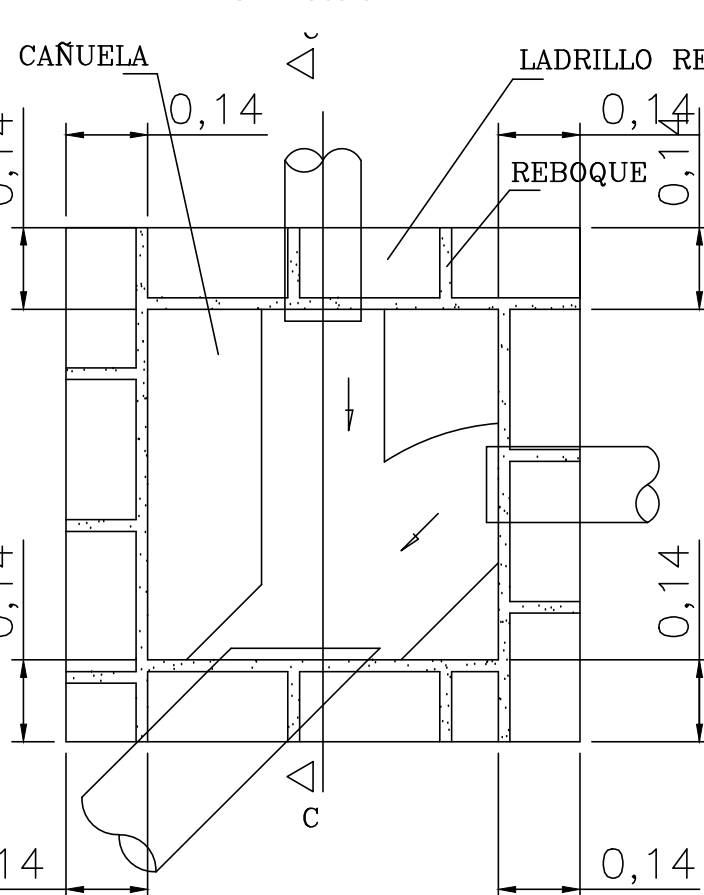

PLANTA CAJA DE INSPECCION

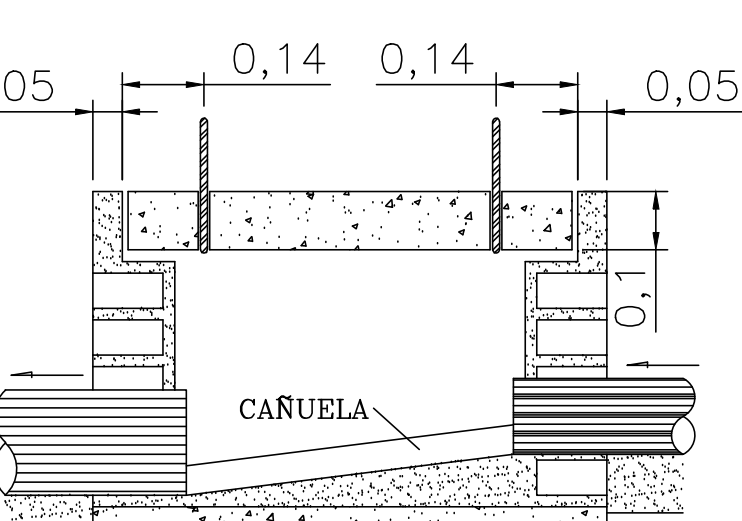

CONCRETO PLACA DE CONCRETO REFORZADO CON HIERRO DE 3/8 RECEO COMPACTADO

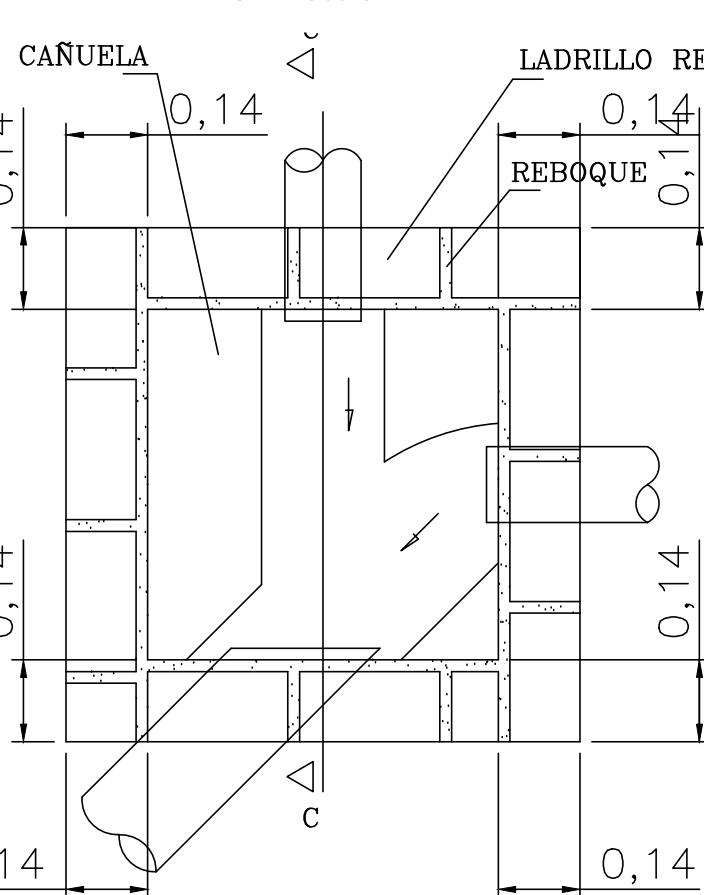

PLANTA CAJA DE INSPECCION

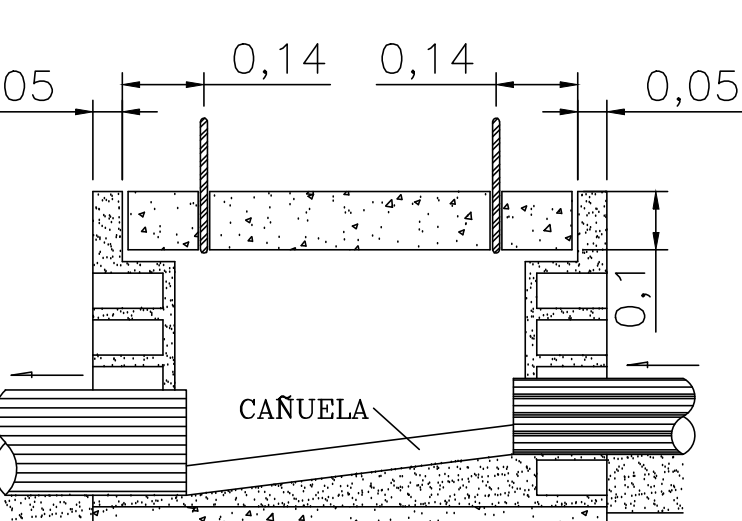

CONCRETO PLACA DE CONCRETO REFORZADO CON HIERRO DE 3/8 RECEO COMPACTADO

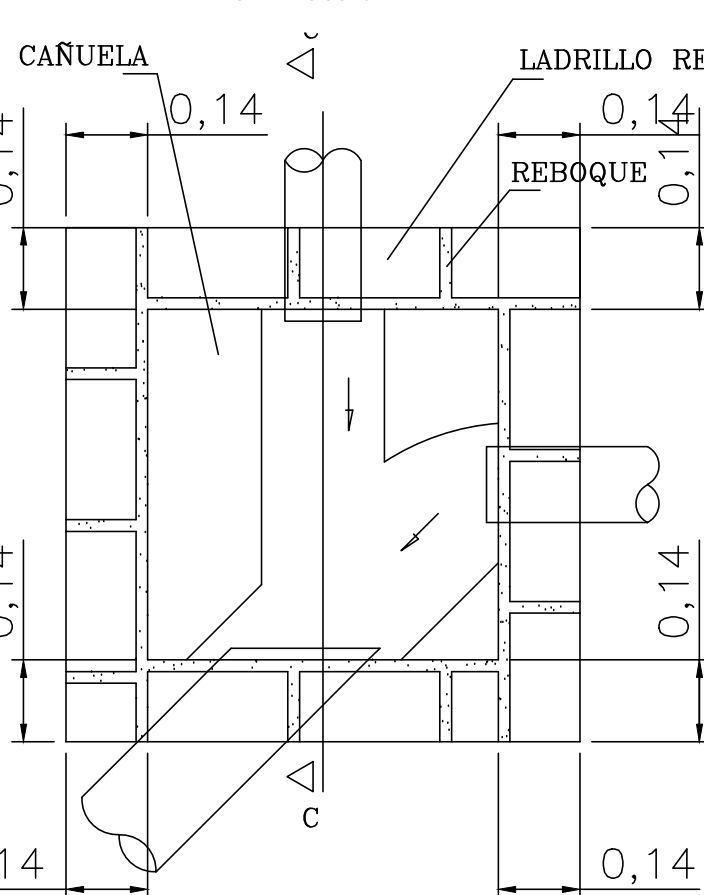

PLANTA CAJA DE INSPECCION

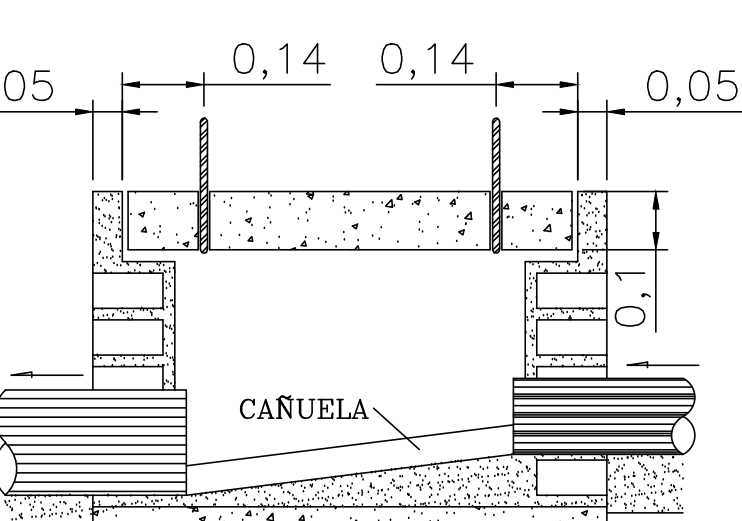

CONCRETO PLACA DE CONCRETO REFORZADO CON HIERRO DE 3/8 RECEO COMPACTADO

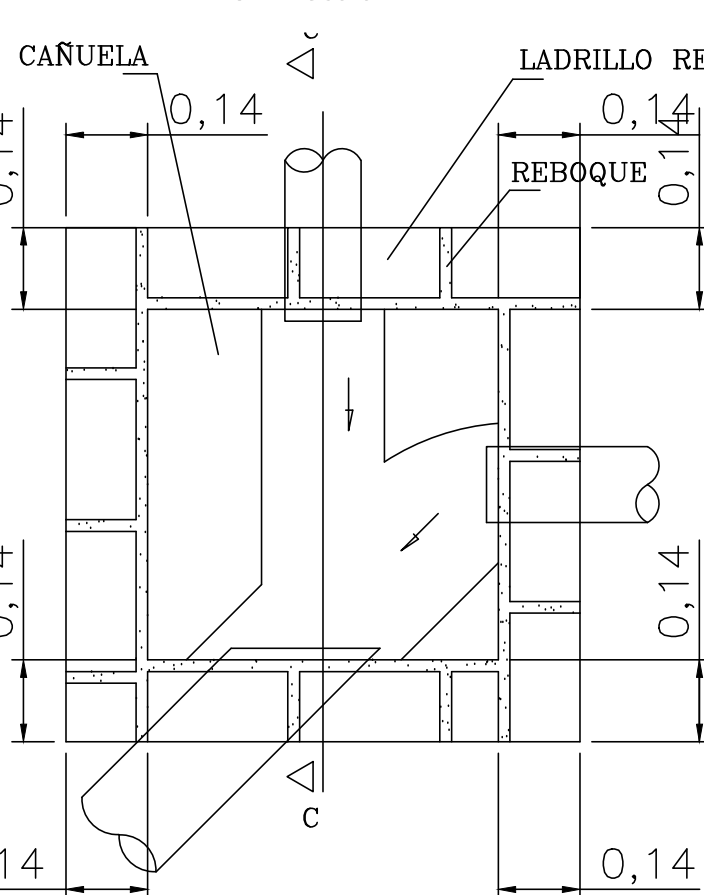

PLANTA CAJA DE INSPECCION

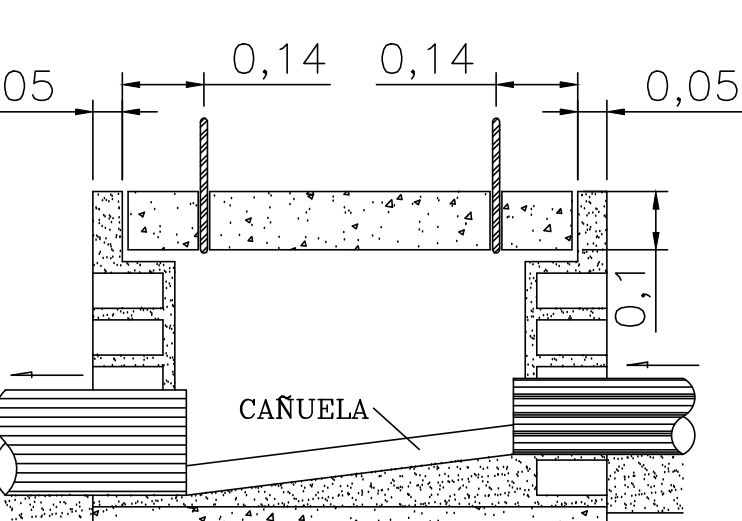

CONCRETO PLACA DE CONCRETO REFORZADO CON HIERRO DE 3/8 RECEO COMPACTADO

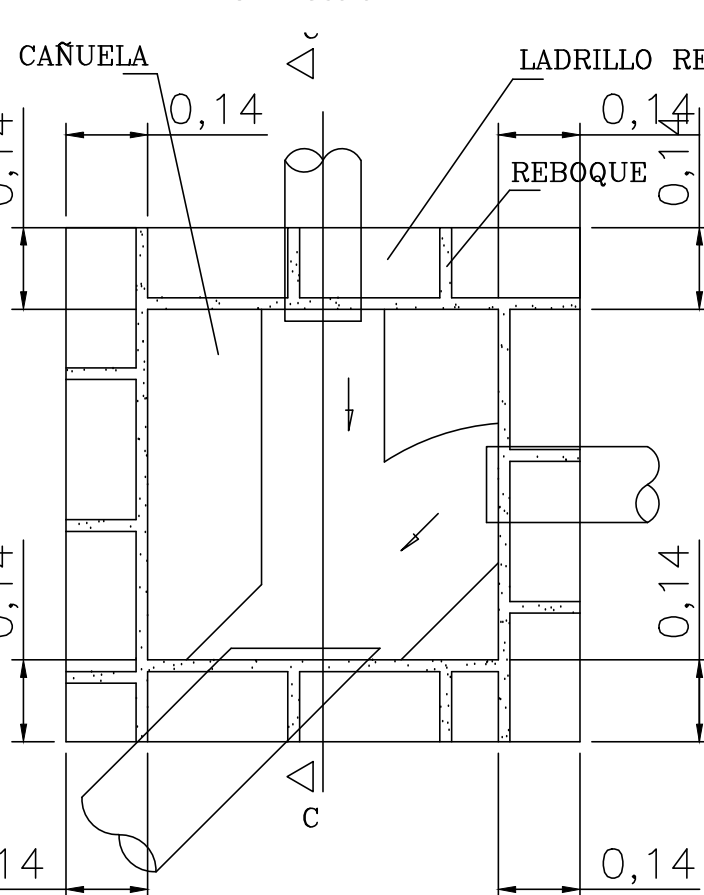

PLANTA CAJA DE INSPECCION

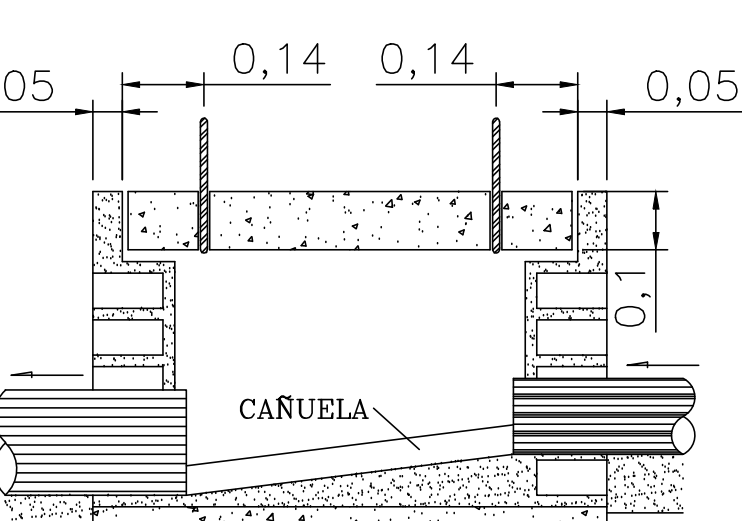

CONCRETO PLACA DE CONCRETO REFORZADO CON HIERRO DE 3/8 RECEO COMPACTADO

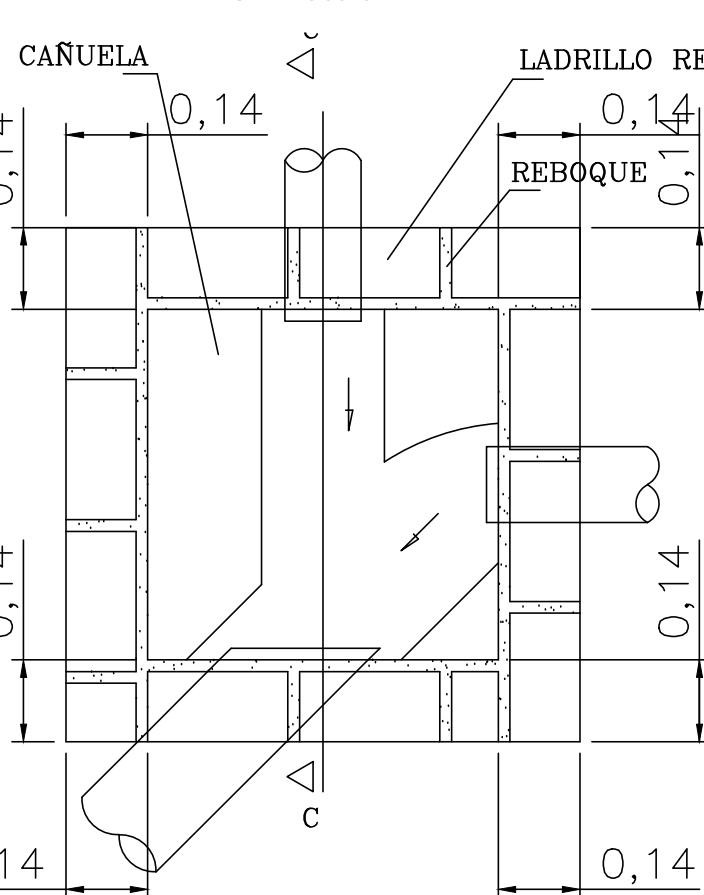

PLANTA CAJA DE INSPECCION

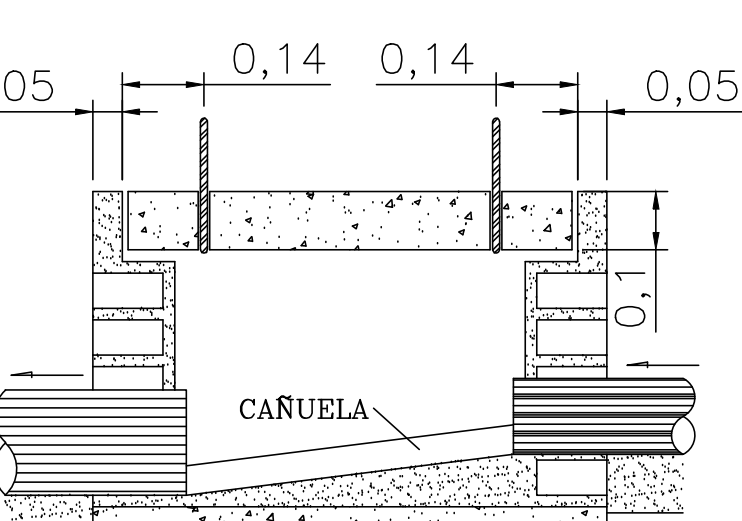

CONCRETO PLACA DE CONCRETO REFORZADO CON HIERRO DE 3/8 RECEO COMPACTADO

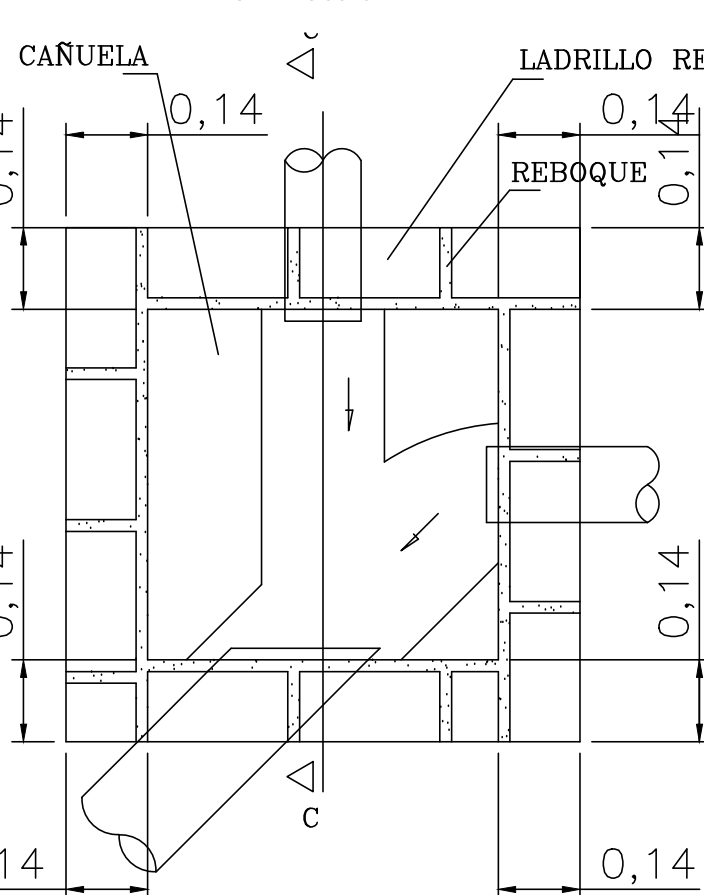

PLANTA CAJA DE INSPECCION

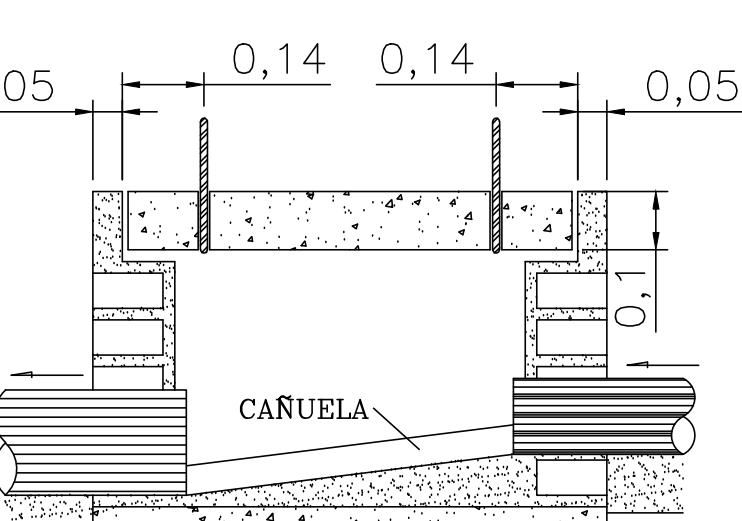

CONCRETO PLACA DE CONCRETO REFORZADO CON HIERRO DE 3/8 RECEO COMPACTADO

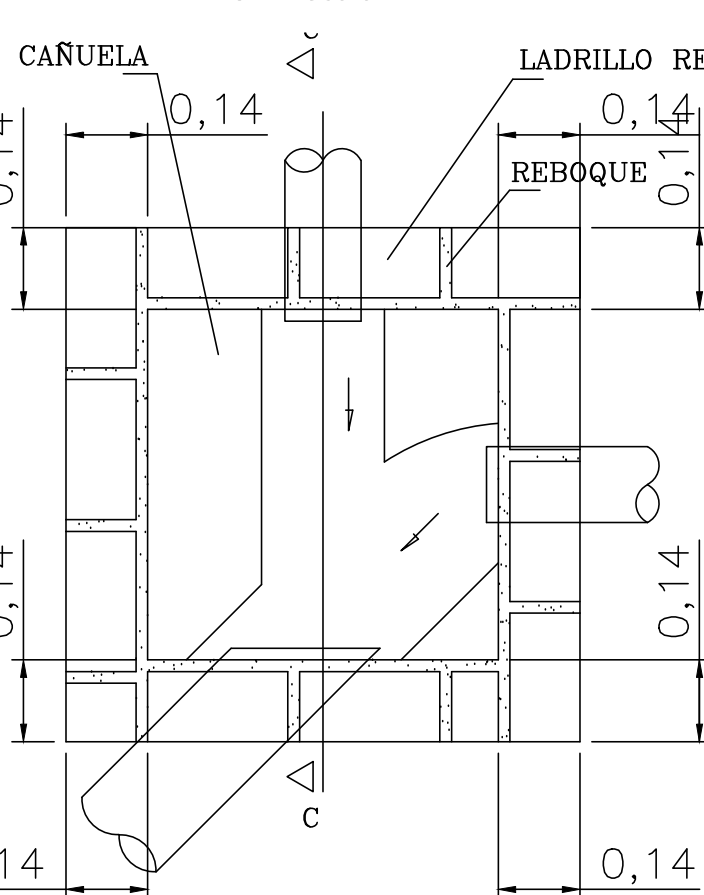

PLANTA CAJA DE INSPECCION

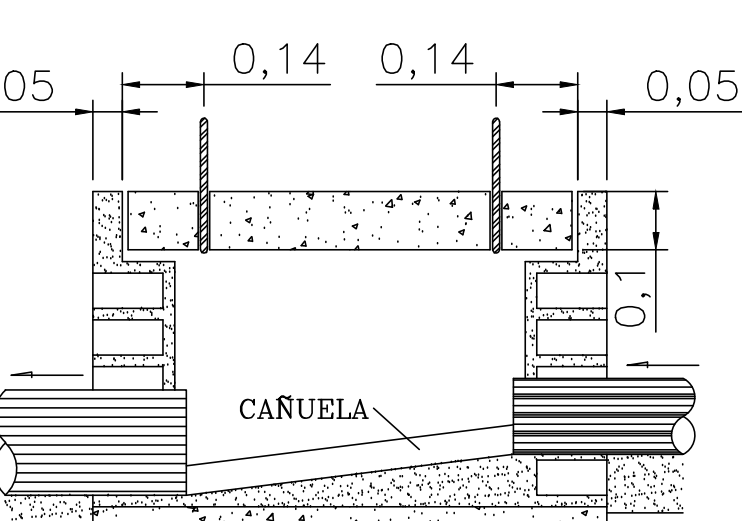

CONCRETO PLACA DE CONCRETO REFORZADO CON HIERRO DE 3/8 RECEO COMPACTADO

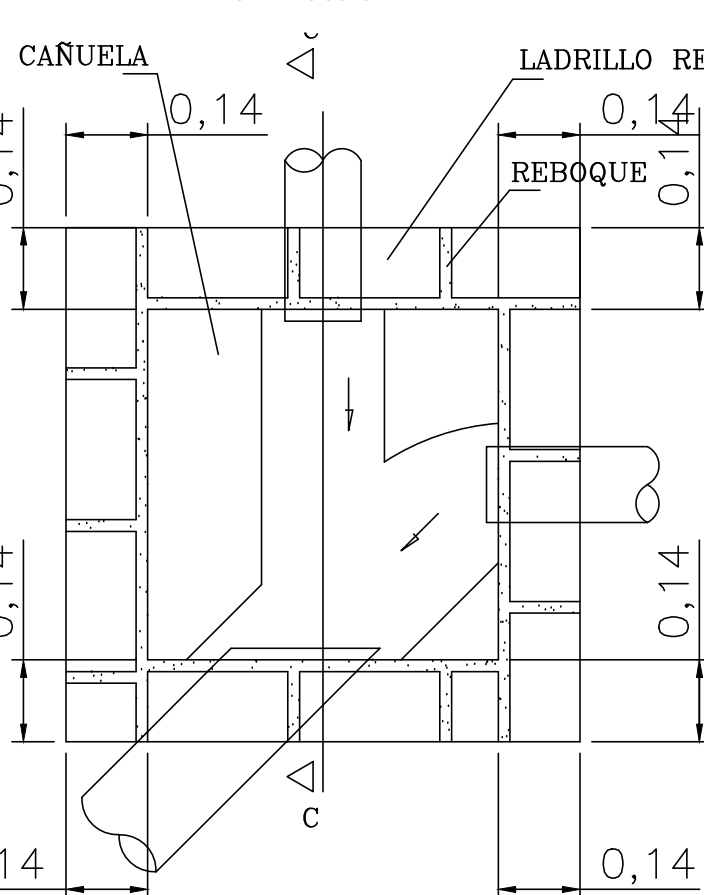

PLANTA CAJA DE INSPECCION

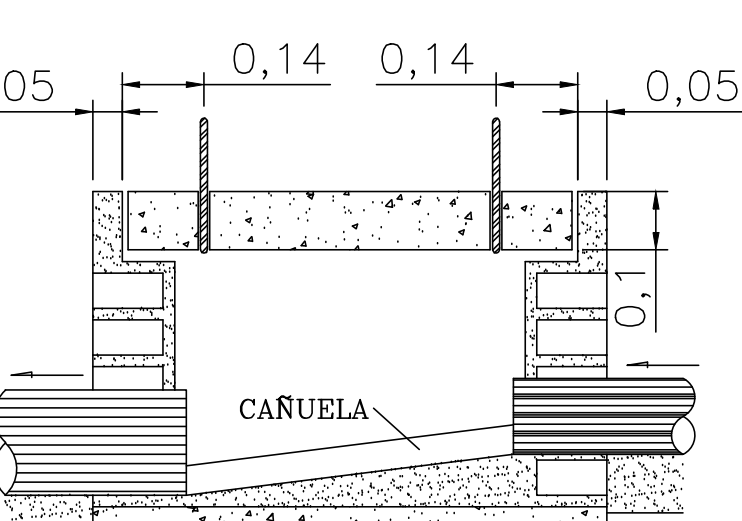

CONCRETO PLACA DE CONCRETO REFORZADO CON HIERRO DE 3/8 RECEO COMPACTADO

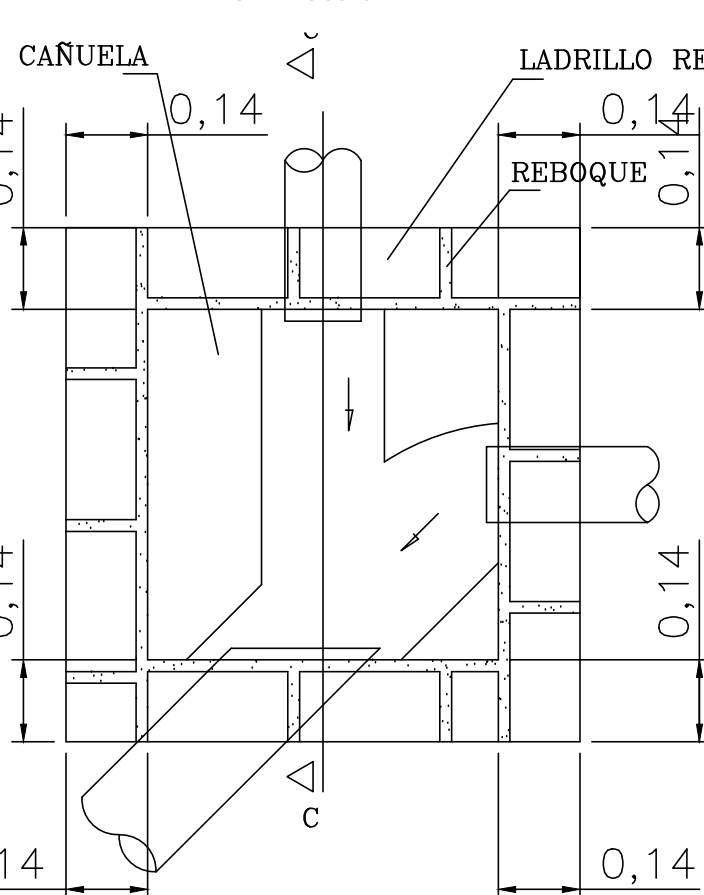

PLANTA CAJA DE INSPECCION

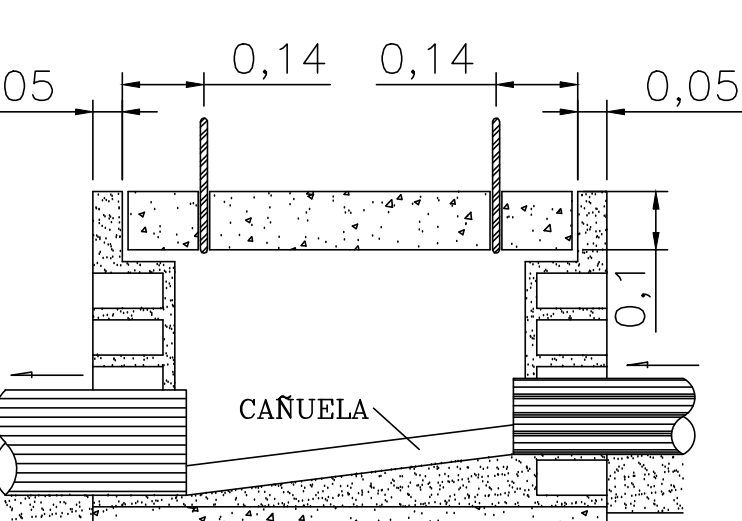

CONCRETO PLACA DE CONCRETO REFORZADO CON HIERRO DE 3/8 RECEO COMPACTADO

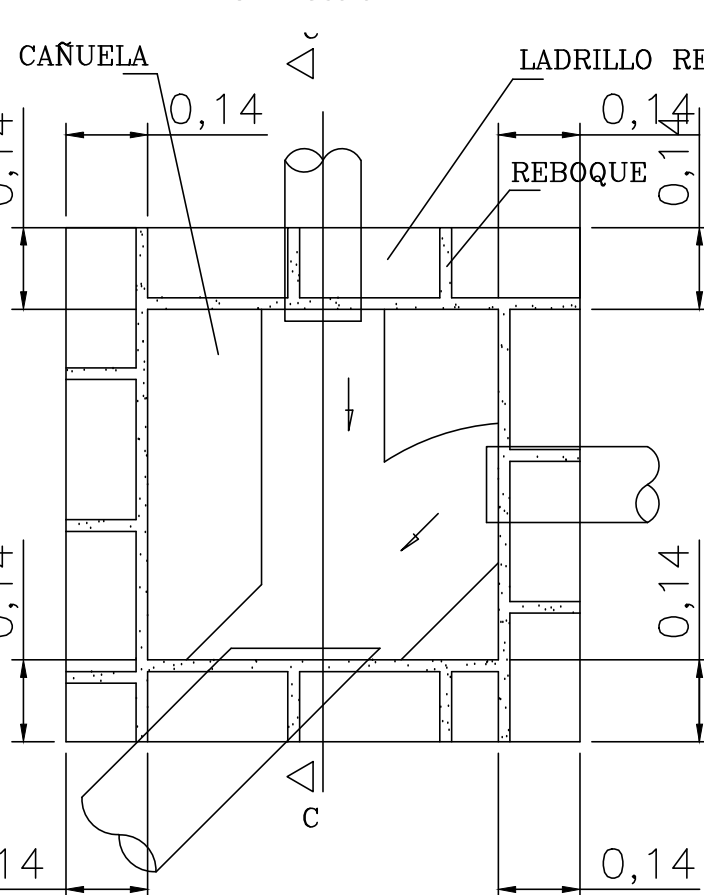

PLANTA CAJA DE INSPECCION

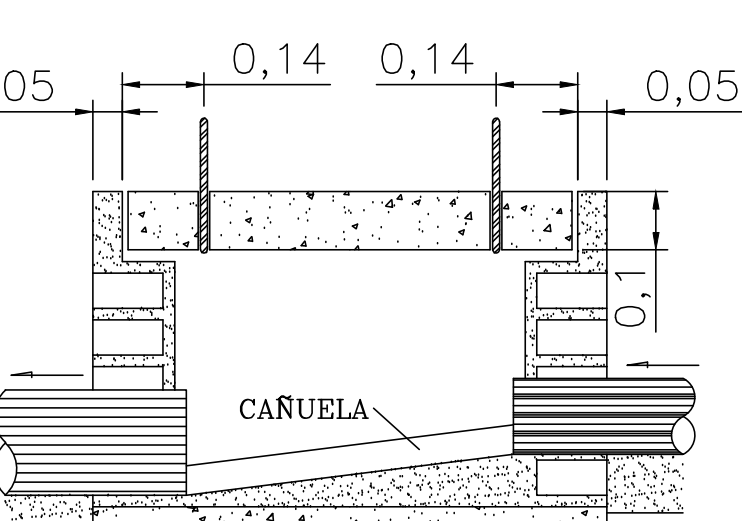

CONCRETO PLACA DE CONCRETO REFORZADO CON HIERRO DE 3/8 RECEO COMPACTADO

